

TOSVERT VF-AS3/S15/MB1

DeviceNet Option Function Manual

DEV003Z

NOTICE

1. Read this manual before installing or operating. Keep this instruction manual on hand of the end user, and make use of this manual in maintenance and inspection.
2. All information contained in this manual will be changed without notice. Please contact your Toshiba distributor to confirm the latest information.

Contents

1. Introduction.....	2
2. Connection Information	7
2.1. Connection Sizes	7
2.2. Exterior Overview.....	7
2.3. DeviceNet Connector.....	8
2.4. DeviceNet LED Indicator	9
3. Hardware Setup.....	11
3.1. Mounting and removing	11
4. Inverter's Communications-related Parameters	12
5. Local/Remote	14
6. Object Specifications	15
6.1. Identity Object.....	16
6.2. Message Router Object.....	18
6.3. DeviceNet Object.....	19
6.4. Assembly Object.....	20
6.5. Connection Object	47
6.6. Motor Data Object.....	51
6.7. Control Supervisor Object.....	52
6.8. AC/DC Drive Object.....	55
6.9. Acknowledge Handler Object	57
6.10. Parameter Object (Vender Specific Profiles).....	58
7. DeviceNet Local/Remote Operation	59
8. EDS File	61
9. Specifications	62

1. Introduction

Thank you for purchasing the DeviceNet option “DEV003Z”. Before using the DeviceNet option, please familiarize yourself with the product and be sure to thoroughly read the instructions and precautions contained in this manual.

This option needs the option adaptor to connect VF-S15 which type form is SBP009Z. Please match here and buy it when SBP009Z is not at hand yet.

This manual describes the supported functions for the “DEV003Z”.

In conjunction with this manual, the following manuals are supplied by Toshiba, and are essential both for ensuring a safe, reliable system installation as well as for realizing the full potential of the “DEV003Z”:



- TOSVERT VF-AS3 Instruction Manual.....	E6582062
- TOSVERT VF-S15 Instruction Manual	E6581611
- TOSVERT VF-MB1 Instruction Manual	E6581697
- VF-AS3/S15/MB1 Communication option Precautions Manual	E6582127
- TOSVERT VF-AS3 Series RS485 Communication Function Instruction Manual.....	E6582142
- TOSVERT VF-S15 Series RS485 Communication Function Instruction Manual.....	E6581913
- TOSVERT VF-S15 Option adaptor Instruction Manual	E6581838
- TOSVERT VF-MB1 Series RS485 Communication Function Instruction Manual	E6581726

DeviceNet is registered trademarks of ODVA (Open DeviceNet Vendor Association, Inc.).

Safety precautions

On the inverter and in its instruction manual, important information is contained for preventing injuries to users and damages to assets and for proper use of the device. Read the instruction manual attached to the inverter along with this instruction manual for completely understanding the safety precautions and adhere to the contents of these manuals.



Explanation of markings

Marking	Meaning of marking
 Warning	Indicates that errors in operation may lead to death or serious injury.
 Caution	Indicates that errors in operation may lead to injury (*1) to people or that these errors may cause damage to physical property. (*2)



(*1) Such things as injury, burns or shock that will not require hospitalization or long periods of outpatient treatment.

(*2) Physical property damage refers to wide-ranging damage to assets and materials.



Meanings of symbols

Marking	Meaning of marking
	Indicates prohibition (Don't do it). What is prohibited will be described in or near the symbol in either text or picture form.
	Indicates something mandatory (must be done). What is mandatory will be described in or near the symbol in either text or picture form.
	Indicates warning. What is warned will be described in or near the symbol in either text or picture form. Indicates caution. What the caution should be applied to will be described in or near the symbol in either text or picture form.



■ General Operation

⚠ Warning	
 Disassembly prohibited	<ul style="list-style-type: none"> ▼ Never disassemble, modify or repair. Doing so could result in electric shock, fire and injury. For repairs, call your sales agency.
 Prohibited	<ul style="list-style-type: none"> ▼ When the inverter is energized, never detach the option from the inverter or SBP009Z (option adapter). Doing so could result in electric shock, the inverter, DEV003Z and SBP009Z breakage. ▼ Do not place or insert any kind of object (electrical wire cuttings, rods, wires) into the option. Doing so could result in electric shock or fire. ▼ Do not allow water or any other fluid to come in contact with DEV003Z. Doing so could result in electric shock or fire. ▼ Do not add the impact to DEV003Z or SBP009Z. Doing so could result in the inverter, DEV003Z or SBP009Z breakage. ▼ Do not touch the connector of VF-S15, DEV003Z and SBP009Z. Doing so could result in injury or DEV003Z/SBP009Z breakage.
 Mandatory	<ul style="list-style-type: none"> ▼ Turn off the inverter when installing and wiring this option. ▼ If the inverter begins to emit smoke or an unusual odor, or unusual sounds, immediately turns power off. If the equipment is continued in operation in such a state, the result may be fire. Call your local sales agency for repairs.



■ Transportation & installation

⚠ Warning	
 Prohibited	<ul style="list-style-type: none"> ▼ Do not operate the inverter if it is damaged or any component is missing. Doing so could result in electric shock or fire. Call your local sales agency for repairs. ▼ Do not place any inflammable substances near the VF- MB1/S15 inverter. If an accident occurs in which flame is emitted, this could lead to fire. ▼ Do not install in any location where the inverter could come into contact with water or other fluids. Doing so could result in electric shock or fire.
 Mandatory	<ul style="list-style-type: none"> ▼ Operate under the environmental conditions prescribed in the instruction manual. Operations under any other conditions may result in malfunction.



■ Wiring

 Warning	
 Mandatory	<ul style="list-style-type: none"> ▼ Shut off power when installing and wiring this option. Wait at least 15 minutes and check to make sure that the charge lamp (the inverter) is no longer lit. ▼ Use an additional safety device with your inverter or system to prevent a serious accident due to the unit malfunctions. Usage without an additional safety device may cause an accident. ▼ Electrical construction work must be done by a qualified expert. Installation or connection of input power by someone who does not have that expert knowledge may result in fire or electric shock.

■ Operations

 Warning	
 Prohibited	<ul style="list-style-type: none"> ▼ Do not touch switches when the hands are wet and do not try to clean the inverter with a damp cloth. Doing so could result in electric shock. ▼ Do not pull on any cable itself. Doing so could result in damage or malfunction.
 Mandatory	<ul style="list-style-type: none"> ▼ Check DeviceNet state (using below attribute) when the option is deactivated by an unusual event such as an operating error, power outage, failure, etc. - Identity Object Instance Attributes 8 (State) (The communication error occurs when Fault (4, 5) or this value cannot be read.) Deactivated option may cause an accident, if the DeviceNet state is not checked. ▼ Make sure that the operation signals are STOP before clearing the inverter's fault. The motor may suddenly start and that may result in injuries.

■ Disposal

 Caution	
 Mandatory	<ul style="list-style-type: none"> ▼ For safety's sake, do not dispose of the disused inverter yourself but ask an industrial waste disposal agent (*). If the collection, transport and disposal of industrial waste is done by someone who is not licensed for that job, it is a punishable violation of the law. (Laws in regard to cleaning and processing of waste materials) (*) Persons who specialize in the processing of waste and known as "industrial waste product collectors and transporters" or "industrial waste disposal persons."

Notes on use

Notes

- ▼ Do not install the inverter where the temperature or the humidity will change rapidly.
- ▼ Keep a distance of 20cm or more between the inverter's power cable and the data transmission cable.
Or the inverter might malfunction because of noise.
- ▼ Insert a magnetic contactor or similar device between the inverter and the power supply to ensure that power is turned off if an emergency stop command is entered through the network.
- ▼ When the control power is shut off by the instantaneous power failure, communication will be unavailable for a while.
- ▼ Do not use application of writing into inverter parameters more than 100,000 times.
The Life of EEPROM is approximately 100,000 times.
Frequent writing to the EEPROM of inverter will cause a memory corruption.

2. Connection Information

2.1. Connection Sizes

Connection Instance	Produced	Consumed
I/O Messaging	4, 8, 12 or 18 bytes	4, 8, 12 or 18 bytes
Explicit Messaging	39 bytes	39 bytes

- For the Polled I/O connection, if the actual consumed data size is bigger than the connection instance's Consumed connection size attribute, the consumed data will be ignored, but the connection will otherwise produce normally. If the actual consumed data size is larger than the connection instance's consumed_connection_size attribute, the consumed data will be ignored and the connection will not produce.
- For the Explicit Messaging connection, this is the maximum message length: shorter messages are also acceptable.

2.2. Exterior Overview

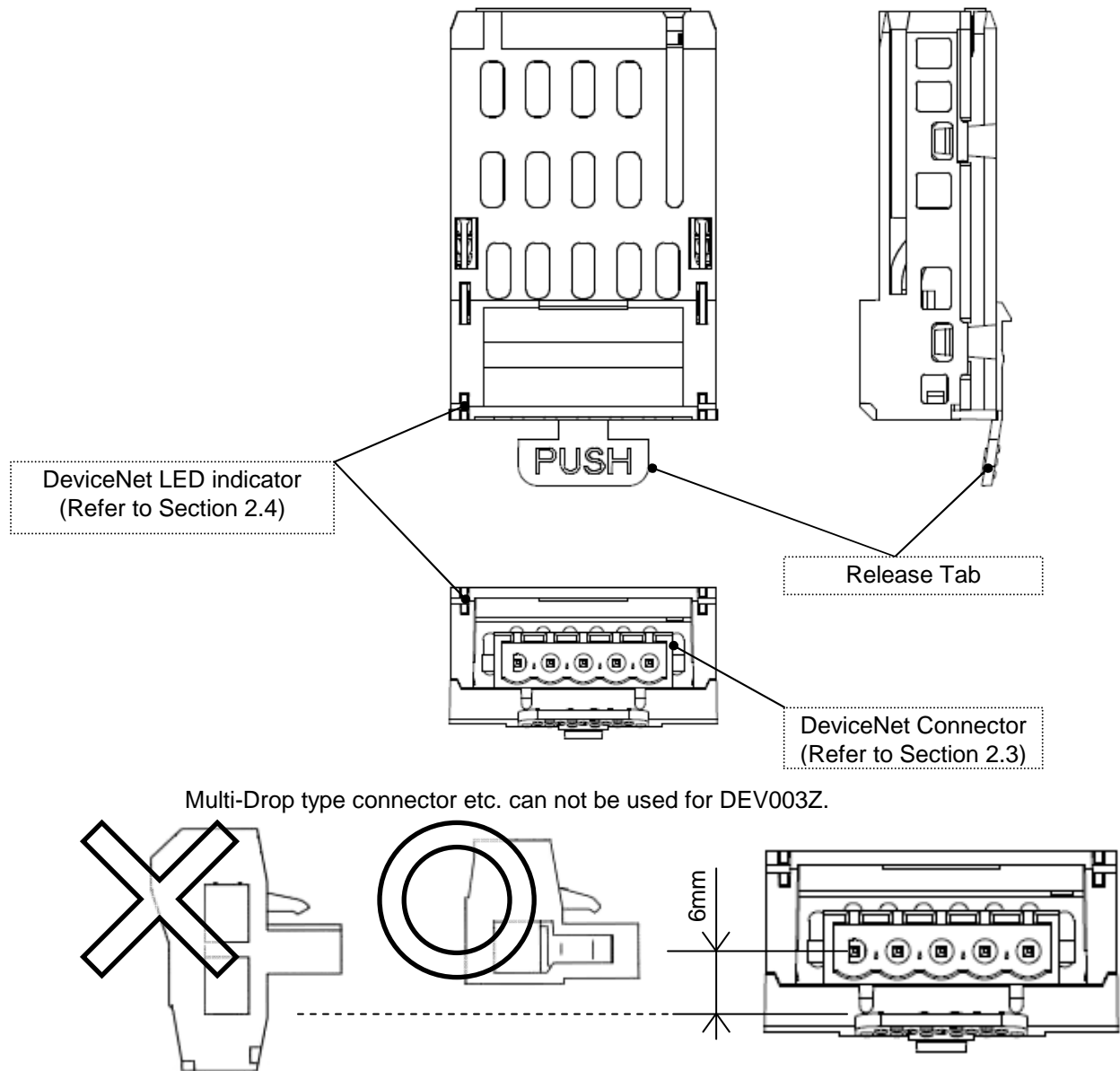

2.3. DeviceNet Connector

DeviceNet network connector is plug type, and pin-assigns are followings.

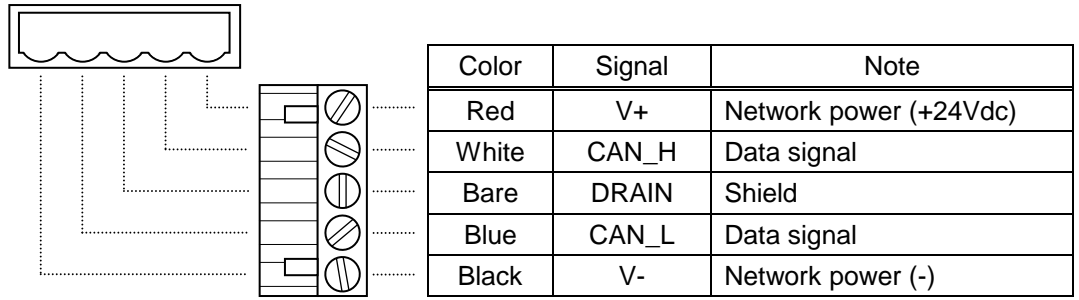

- Wire size : 0.3 to 1.5mm² (AWG22-16).
- Jacket strip : 30 to 80 mm.
- Signal/Power jacket strip : 7 to 10mm.
- Tighten Torque : 0.5 to 0.6 N·m
- Screwdriver : Flat-blade screw driver
(0.6 mm Blade thickness, 3.5 mm or less width).

2.4. DeviceNet LED Indicator

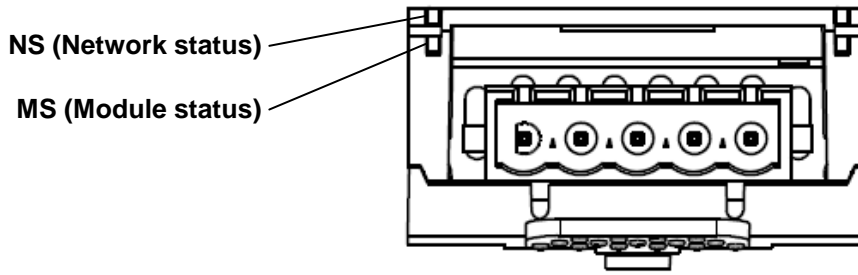

NS (Network status)

This bi-color (green/red) LED indicates the status of the communication link from the DEV003Z to DeviceNet. (According to ODVA DeviceNet Specifications.)

LED is:	For this state:	To indicate:
Off	Not Powered /Not On-line	<ul style="list-style-type: none"> - Device is not on-line. - The device has not completed the Dup_MAC_ID test yet. - The device may not be powered, look at Module Status LED. - No network power present to VF-AS3/S15/MB1.
Green	On-line and connect	<ul style="list-style-type: none"> - The device is on-line and has connections in the established state. DEV003Z is allocated to a Master.
Flashing Green	On-line, not connect	<ul style="list-style-type: none"> - Device is connected to the network but has no connections in the established state. DEV003Z is not allocated to a master.
Flashing Red	Connection Time-out	<ul style="list-style-type: none"> - Recoverable Fault. One or more I/O Connections are in the Timed-Out state.
Red	Critical Link Failure	<ul style="list-style-type: none"> - Non Recoverable fault. The device has detected an error that has rendered it incapable of communicating on the network (Duplicate MAC ID, or Bus-off). Check the parameters [2 0 0] then Cycle power or set "1" to F 8 9 9 to VF-AS3/S15/MB1 to reset this fault.
Flashing Red-Green	Communication Faulted and Received an Identify Comm Fault Request - Long Protocol	<ul style="list-style-type: none"> - A specific Communication Faulted device. The device has detected a Network Access error and is in the Communication Faulted state. The device has subsequently received and accepted an Identify Communication Faulted Request - Long Protocol message.

MS (Module status)

This bi-color (green/red) LED indicates the status of the communication link from DEV003Z to the inverter. It indicates whether or not the device has power and is operating properly. (According to ODVA DeviceNet Specifications.)

LED is:	For this state:	To indicate:
Off	Power OFF	There is no power applied to DEV003Z (VF-AS3/S15/MB1).
Green	Device Operational	The device is operating in a normal condition.
Flashing Green	Device in Standby	The device needs commissioning due to configuration missing, incomplete or incorrect. The Device may be in the Standby state.
Flashing Red	Minor Fault	Recoverable Fault. (ex. Network Power Unavailable)
Red	Unrecoverable Fault	The device has an unrecoverable fault; may need replacing.
Flashing Red-Green	Device Self Testing	The Device is in Self Test.

DeviceNet LED Indicator on VF-AS3

When DeviceNet option is used, please attach the LED label for DeviceNet option to lower side of communication indicator of VF-AS3.

The LED label is included in danger label kit of VF-AS3.

NS (Network status) and MS (Module status) are displayed together to MNS on communication indicator.

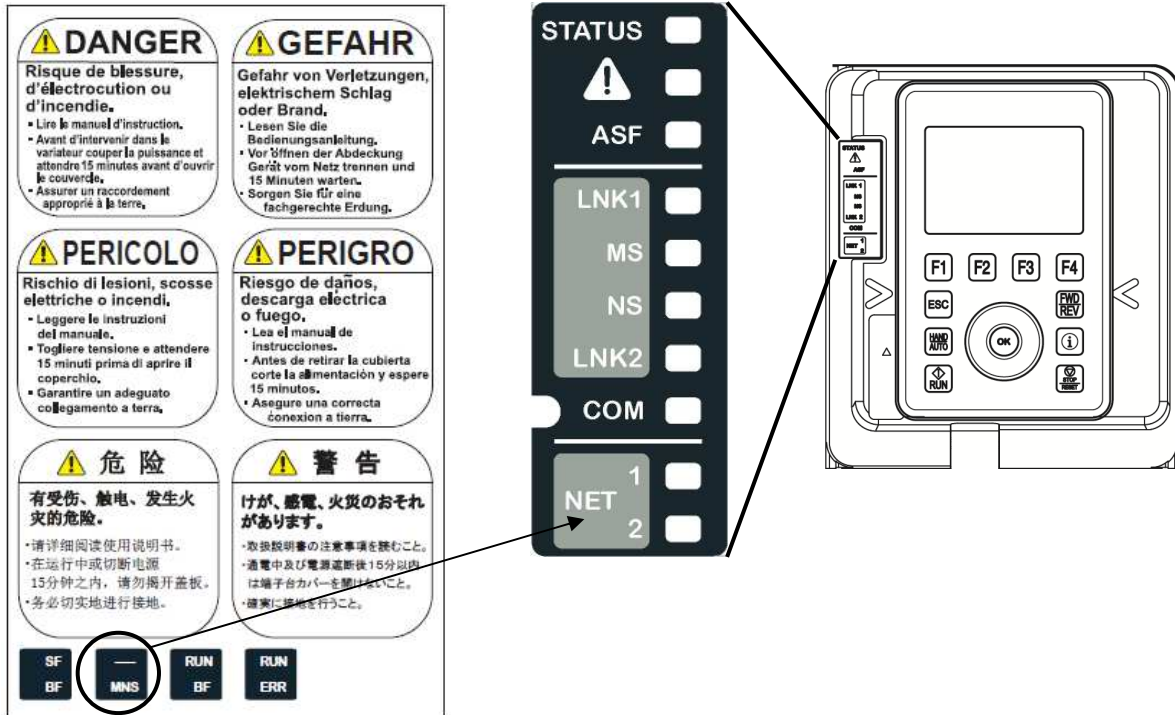

LED is:	For this state:	To indicate:
Off	Not Powered/Not On-line	Device is not on-line. - The DEV003Z has not completed the Dup_MAC_ID test yet. - The DEV003Z may not be powered.
Green	Device Operational AND On-line, Connected	The DEV003Z is operating in a normal condition and the DEV003Z is on-line with connections in the established state.
Flashing Green	Device Operational AND On-line, Not Connected or Device On-line AND Device needs commissioning	The DEV003Z is operating in a normal condition and the DEV003Z is on-line with no connections in the established state. - The DEV003Z has passed the Dup_MAC_ID test, is on-line, but has no established connections to other nodes. - Configuration missing, incomplete or incorrect.
Flashing Red	Minor Fault and/or Connection Time-Out	Recoverable fault and/or one or more I/O Connections are in the Timed-Out state.
Red	Critical Fault or Critical Link Failure	The DEV003Z has an unrecoverable fault; may need replacing. Failed communication device. The DEV003Z has detected an error that has rendered it incapable of communicating on the network (Duplicate MAC ID, or Bus-off).
Alternating between red and green.	Communication Faulted and Received an Identify Comm Fault Request - Long Protocol	A specific Communication Faulted device. The DEV003Z has detected a Network Access error and is in the Communication Faulted state. The DEV003Z has subsequently received and accepted an Identify Communication Faulted Request - Long Protocol message.

3. Hardware Setup

When using this product with VF-S15, sold separately VF-S15 option adapter (SBP009Z) is required.

3.1. Mounting and removing

Warning



Mandatory
action

- ▼ The mounting/removing of option must be performed without supplying power(Turn off all input power, wait at least 15 minutes, confirm that the charge lamp of inverter is no longer lit). The inverter and option can become damaged.
- ▼ Do not use tool for the mounting/removing of option . The inverter and option can become damaged.

3.1.1. Mounting and removing of option for VF-MB1

For how to mount and remove, refer to [Optional external devices] of E6581697.

3.1.2. Mounting and removing of option for VF-S15

For how to mount and remove, refer to [Optional external devices] of E6581611.

3.1.3. Mounting and removing of option for VF-AS3

For how to mount and remove, refer to [Mounting/removing insert type options] of E6582062.

4. Inverter's Communications-related Parameters

In a network, the inverter (DEV003Z) serves as a DeviceNet slave device. DEV003Z configuration is set by the following parameters.

Parameter	Function	Adjustment range	Default setting
<i>C200</i>	DEV003Z MAC ID	0 to 63	63
<i>C201</i>	DEV003Z Communication baud rate	DEV003Z communication baud rate is set. 0: AUTO * 1: 125kbps 2: 250kbps 3: 500kbps	0
<i>C202</i>	DeviceNet Baud rate monitor	DeviceNet communication baud rate is shown. 1: 125kbps 2: 250kbps 3: 500kbps	-
<i>C203</i>	DEV003Z Assembly Object	0: Instance 20/70 1: Instance 21/71 2: Instance 100/150 3: Instance 101/151 4: Instance 102/152 5: Instance 105/155 6: Instance 106/156 (Only VF-AS3)	0
<i>C100</i>	Communication error detection delay time	0.0 to 100.0s	0.0
<i>C101</i>	Inverter operation at the communications loss action (Network wire breaks)	0: Stop and Communication release ** (follows <i>C100</i> and <i>F100</i> setting) 1: Operation continue 2: Deceleration stop 3: Coast stop 4: Emergency stop (<i>ErrB</i>) *** 5: Preset speed operation command (Operating at the preset speed operation frequency set with <i>C102</i>)	4
<i>C102</i>	Preset speed operation selection	0: None 1 to 15:Preset speed (<i>Sr1-Sr7, F287-F295</i>)	0
<i>C103</i>	Communication time-out condition selection	0: Always 1: When communication mode enable (Both <i>C100</i> and <i>F100</i> or <i>F105</i> (bit 14, 15) are set to COM option) 2: 1+Driving operation	1
<i>C001</i> - <i>C006</i>	Cyclic transmission parameter	0 to 17 (Refer to section 6.4.5.7).	-
<i>C021</i> - <i>C026</i>	Cyclic monitoring parameter	0 to 35 (Refer to section 6.4.5.7).	-
<i>F899</i>	Network option reset setting	0: None 1: Resetting the DEV003Z and the inverter	0
<i>Fd67</i>	DEV003Z version	DEV003Z firmware version (ex. "0x1203" means major(1), minor(2) and revision (03)).	-

* DeviceNet baud rate is 500kbps and with a few slaves in the network, auto baud rate function might not work.

** Do not set at VF-MB1 V1.00.

*** When the parameter is changed, the power must be cycled (or set *F899* to 1) to the inverter for the changes to take effect. Set 1 to *F899* by the DeviceNet communication might not be able to be set.



Caution

Please note that the inverter keeps driving when the communication is lost if 1 (None) is set to the parameter *C101* (Inverter operation at the communications loss action).

Description of parameters (C 100 – C 103) related to communication disconnection

C 100: Communication error detection delay time

Adjustment range: 0.0 - 100.0 sec.

The waiting time of network error detection can be adjusted. If network error was removed during [C 100], inverter will continue normal operation.

C 101: Inverter operation at the communications loss action *

Adjustment range:

0: Turn off bit 10, 14 and 15 of *F A O E*

1: Operation continue

2: Deceleration stop

3: Coast stop

4: Emergency stop (*E r r B*)

5: Preset speed operation command (by [C 102] setting)

When the communication error is detected, inverter will operate in accordance with the setting of [C 101].

C 102: Preset speed operation selection

Adjustment range:

0: None

1 to 15: Preset speed

When the communication error is detected, operation frequency can be selected from preset speed (Only when [C101] is set to 5). When you set "0: None", inverter will operate in accordance with enabled frequency command.

C 103: Communication time-out condition selection

Adjustment range:

0: Always

1: Communication mode enable

2: 1 + during run

Condition of communication error detection can be selected by setting of [C 103].

When [C 103] is set to "1: Communication mode enable", inverter will enable the communication error detection when cmod and fmod are set to Communication option or *F A O E* (bit 14, 15) are set to Enabled.

When [C 103] is set to "2: 1 + during run", inverter detect the communication error during operation only in the above condition.

- * If DeviceNet network 24V power supply is not supplied at the inverter power supply ON, it becomes a treatment of the communication disconnection, and after the extension time of the error of the communication of the setting detection time passes by [C 100], it becomes operation according to the setting of [C 101].

5. Local/Remote

Indication to display Local/Remote mode is on the inverter unit (Refer to the inverter instruction manual for details). DeviceNet option command and setpoint are activated on Remote mode.

DeviceNet option propagates the Local/Remote status to the network as the "Net Ctrl (bit5)" and "Net Ref (bit6)" in "Output Instance" network variable. The inverter has some switches to select the command and setpoint location. Following figure shows the diagram. Refer to the inverter instruction manual for the parameter in detail.

Example: VF-S15/MB1

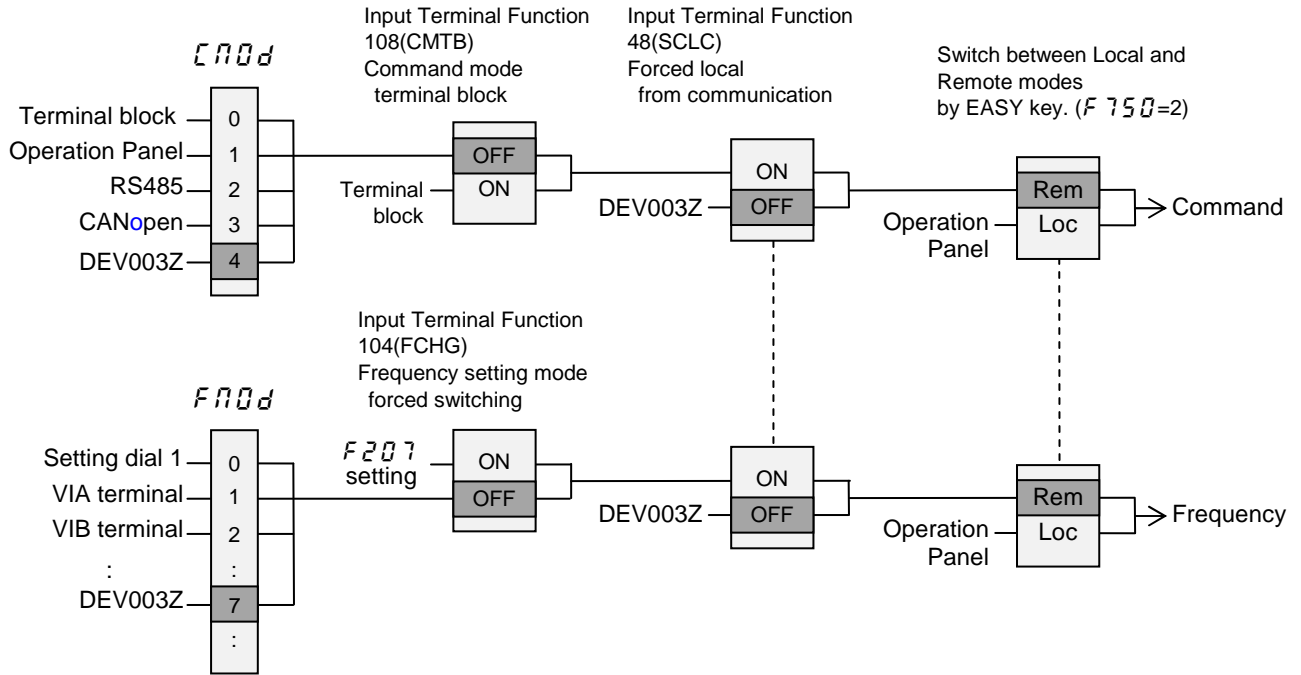

Example: VF-AS3

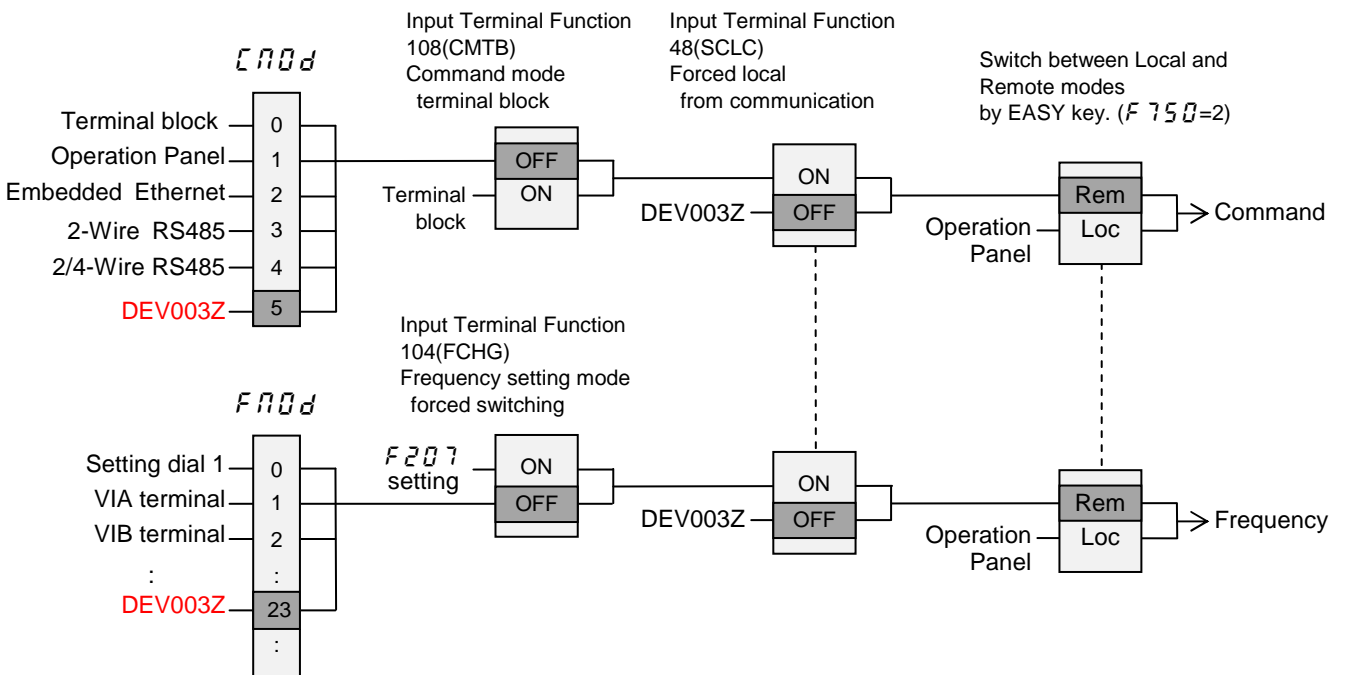

6. Object Specifications

This section contains the object specifications for all DeviceNet objects currently supported by the “DEV003Z”. Table 1 outlines those objects covered:

Class Code	Object Class	Page
0x01	Identity Object	16
0x02	Message Router Object	18
0x03	DeviceNet Object	19
0x04	Assembly Object	20
0x05	Connection Object	47
0x28	Motor Data Object	51
0x29	Control Supervisor Object	52
0x2A	AC/DC Drive Object	55
0x2B	Acknowledge Handler Object	57
0x64, 0x65	Parameter Object (Vender Specific Profiles)	58

Table 1: Supported Objects

For definitions of all data types referred to in these object specifications, refer to the ODVA DeviceNet Specifications. In general, however, the following are some of the most prevalent types:

SINT Signed 8-bit integer value
 USINT Unsigned 8-bit integer value
 BYTE Bit string - 8-bits
 INT Signed 16-bit integer value
 UINT Unsigned 16-bit integer value
 WORD Bit string - 16-bits
 UDINT Unsigned 32-bit integer value

6.1. Identity Object

Class code 0x01. This object provides identification of and general information about the device.

6.1.1. Identity Object Class Attributes

Attribute ID	Name	Data Type	Access Rules	Description	Default Value
1	Revision	UINT	Get	Revision of this object	1
2	Max Instance	UINT	Get	Maximum instance number of an object currently created in this class level of the device.	1

6.1.2. Identity Object Instance Attributes

Attribute ID	Name	Data Type	Access Rules	Description	Default Value
1	Vendor ID	UINT	Get	Identification of vendor by number	377
2	Device Type	UINT	Get	Indication of general type of product	2 (AC Drive)
3	Product Code	UINT	Get	Identification of a particular product of an individual vendor	VF-MB1:3000 VF-S15 :3001 VF-AS3:32004
4	Revision	STRUCT OF	Get	Revision of the item the Identity Object represents	-
	Major Revision *	USINT	Get	-	(01)
	Minor Revision *	USINT	Get	-	(01)
5	Status **	WORD	Get	Summary status of device	-
6	Serial Number	UDINT	Get	Serial number of device	-
7	Product Name	SHORT_STRING	Get	Human-readable identification	"DEV003Z"
8	State	USINT	Get	Present state of the device 0 = Non-existent 1 = Device Self Testing 2 = Standby 3 = Operational 4 = Major Recoverable Fault 5 = Major Unrecoverable Fault	-
10	Heartbeat Interval	USINT	Get/Set	The nominal interval between heartbeat messages in seconds.	0

* DEV003Z software version.

ex.) If Major = 0x01 and Minor = 0x01, DEV003Z Version is "101".

** Attribute 5 Status:

Bit	Note
0	TRUE indicates the device (or an object within the device) has an owner.
2	TRUE indicates the application of the device has been configured to do something different than the "out-of-box" default. This shall not include configuration of the communications.
4-7	Extended device status 0000 = Self-Testing or Unknown 0010 = At least one faulted I/O connection 0011 = No I/O connection established 0100 = Non volatile configuration bad 0101 = Major fault 0110 = At least one I/O connection in run mode 0111 = At least one I/O connection established, all in idle mode
8	Minor Recoverable Fault
9	Minor Unrecoverable Fault.
10	Major Recoverable Fault.
11	Major Unrecoverable Fault
etc.	0 (Reserved)

6.1.3. Identity Object Common Services

Service Code	Service Name	Supported		Description of Service
		Class	Instance	
0x05	Reset	N/A	Yes	Invokes the Reset service for the device
0x0E	Get Attribute Single	Yes	Yes	Returns the contents of the specified attribute.
0x10	Set Attribute Single	N/A	Yes	Modifies the value of the specified attribute.

6.1.4. Identity Object Specific Services

Identity Object provides no object specific services.

6.2. Message Router Object

Class Code 0x02. The Message Router Object provides a messaging connection point through which a Client may address a service to any object class or instance residing in the physical device.

6.2.1. Message Router Object Class Attributes

Attribute ID	Name	Data Type	Access Rules	Description	Default Value
1	Revision	UINT	Get	Revision of this object	1
2	Max Instance	UINT	Get	Maximum instance number of an object currently created in this class level of the device	1

6.2.2. Message Router Object Instance Attributes

Attribute ID	Name	Data Type	Access Rules	Description	Default Value
1	Object List	STRUCT of	Get	A list of supported objects	-
	Number	UINT	Get	Number of supported classes in the classes array	11
	Classes	ARRAY of UINT	Get	List of supported class codes	-
2	Number Available	UINT	Get	Maximum number of connections supported	16
3	Number Active	UINT	Get	Number of connections currently used by system components	-
4	Active Connections	ARRAY of UINT	Get	A list of the connection IDs of the currently active connections	-

6.2.3. Message Router Object Common Services

Service Code	Service Name	Supported		Description of Service
		Class	Instance	
0x0E	Get Attribute Single	Yes	Yes	Returns the contents of the specified attribute.

6.2.4. Message Router Object Specific Services

Message Router Object provides no object specific services.

6.3. DeviceNet Object

Class Code 0x03. The DeviceNet Object provides for the configuration and status of a DeviceNet port.

6.3.1. DeviceNet Object Class Attributes

Attribute ID	Name	Data Type	Access Rules	Description	Default Value
1	Revision	UINT	Get	Revision of this object.	2
2	Max Instance	UINT	Get	Maximum instance number of an object currently created in this class level of the device	1

6.3.2. DeviceNet Object Instance Attributes

Attribute ID	Name	Data Type	Access Rules	Description	Default Value
1	MAC ID	USINT	Get	Node address (0-63)	63
2	Baud Rate	USINT	Get	Baud rate 0 = 125kbps 1 = 250kbps 2 = 500kbs	-
3	Bus-off Interrupt	BOOL	Get/Set	Bus-Off Interrupt	0
4	Bus-off Counter	USINT	Get/Set	Number of times CAN went to the bus-off state	0
5	Allocation Information (Allocation Choice Byte*)	BYTE	Get	Master/Slave allocation state	-
	Allocation Information (Master's MAC ID**)	USINT	Get	MAC ID of Master ** (from Allocate)	-

* The value 255 (0xFF) means the Predefined Master/Slave Connection set has not been allocated.

6.3.3. DeviceNet Object Common Services

Service Code	Service Name	Supported		Description of Service
		Class	Instance	
0x0E	Get Attribute Single	Yes	Yes	Returns the contents of the specified attribute.
0x10	Set Attribute Single	N/A	Yes	Modifies the value of the specified attribute.

6.3.4. DeviceNet Object Specific Services

Service Code	Service Name	Supported		Description of Service
		Class	Instance	
0x4B	Allocate_Master/Slave_Connection_Set	N/A	Yes	Requests the use of the Predefined Master/Slave Connection Set.
0x4C	Release_Group_2_Identifier_Set	N/A	Yes	Indicates that the specified connections within the <i>Predefined Master/Slave Connection Set</i> are no longer desired. These connections are to be released (deleted).

* Attribute 5 Allocation Choice Byte

Bit	Note
0	Explicit
1	Poll
2	Bit Strobe
3	Multicast Poll
4	Change of State
5	Cyclic
6	ACK Suppression
7	(Reserved)

6.4. Assembly Object

Class code 0x04. The Assembly Object binds attributes of multiple objects, which allows data to or from each object to be sent or received over a single connection.

6.4.1. Assembly Object Class Attributes

Attribute ID	Name	Data Type	Access Rules	Description	Default Value
1	Revision	UINT	Get	Revision of this object.	2
2	Max Instance	UINT	Get	Maximum instance number of an object currently created in this class level of the device	VF-MB1:155 VF-S15 :155 VF-AS3:156

6.4.2. Assembly Object Instance Attributes

Attribute ID	Name	Data Type	Access Rules	Description	Default Value
3	Data	ARRAY of BYTE	Get/Set	The data contained in the assembly object. (Refer to section 6.4.5)	-

6.4.3. Assembly Object Common Services

Service Code	Service Name	Supported		Description of Service
		Class	Instance	
0x0E	Get Attribute Single	Yes	Yes	Returns the contents of the specified attribute.
0x10	Set Attribute Single	N/A	Yes	Modifies the value of the specified attribute.

6.4.4. Assembly Object Specific Services

Assembly Object for static assemblies provides no object specific services.

6.4.5. Assembly Instance Details

6.4.5.1. Instance 20/70 - DeviceNet Standard (4 bytes, parameter $\text{C}203 = 0$)

Byte	Bit 7	Bit 6	Bit 5	Bit 4	Bit 3	Bit 2	Bit 1	Bit 0
0	-	-	-	-	-	Fault reset	-	Run forward
1	-							
2	Inverter Reference Speed min^{-1} (Low byte) *							
3	Inverter Reference Speed min^{-1} (High byte) *							

Fig. 1 Output Instance 20 Layout

Byte	Bit 7	Bit 6	Bit 5	Bit 4	Bit 3	Bit 2	Bit 1	Bit 0
0	-	-	-	-	-	Running Forward	-	Faulted/tripped
1	-							
2	Inverter Actual Speed min^{-1} (Low byte)							
3	Inverter Actual Speed min^{-1} (High byte)							

Fig. 2 Input Instance 70 Layout

* When Instance 20/70 is used, set $\text{C}00d$ and $\text{F}00d$ to "Communication option".

Examples of Instance 20/70

① Stop

Instance	Byte	15	14	13	12	11	10	9	8	7	6	5	4	3	2	1	0	Hex.
Output Instance 20	1, 0	0	0	0	0	0	0	0	0	0	0	0	0	0	0	0	0	0x0000
	3, 2	-	-	-	-	-	-	-	-	-	-	-	-	-	-	-	-	-
Input Instance 70	1, 0	0	0	0	0	0	0	0	0	0	0	0	0	0	0	0	0	0x0000
	3, 2	0	0	0	0	0	0	0	0	0	0	0	0	0	0	0	0	0x0000

② Forward running 1800min-1

Instance	Byte	15	14	13	12	11	10	9	8	7	6	5	4	3	2	1	0	Hex.
Output Instance 20	1, 0	0	0	0	0	0	0	0	0	0	0	0	0	0	0	0	1	0x0001
	3, 2	0	0	0	0	0	1	1	1	0	0	0	0	1	0	0	0	0x0708
Input Instance 70	1, 0	0	0	0	0	0	0	0	0	0	0	0	0	0	1	0	0	0x0004
	3, 2	0	0	0	0	0	1	1	1	0	0	0	0	1	0	0	0	0x0708

③ Fault reset **

Instance	Byte	15	14	13	12	11	10	9	8	7	6	5	4	3	2	1	0	Hex.
Output Instance 20	1, 0	0	0	0	0	0	0	0	0	0	0	0	0	0	1	0	0	0x0004
	3, 2	-	-	-	-	-	-	-	-	-	-	-	-	-	-	-	-	-

* Inverter Reference Speed is set up number of rotations by the hexadecimal number.
 For example, when "Frequency reference" is set up to 1800min^{-1} :
 $1800 = 0x0708$ (Hex.)

The rotational speed is converted to the frequency on the inverter side referring to a set value of the parameter $\text{F}856$ (number of motor poles for the communication).
 For example, if the parameter $\text{F}856=2$,
 Output frequency = $1800 \times 2 / 60 = 60\text{Hz}$

In Input Instance, the frequency is converted to rotating speed and output by the inverter.
 For example, if the parameter $\text{F}856=2$,
 Output frequency = $60 / 2 \times 60 = 1800\text{min}^{-1}$

** Fault reset works only 1 time when 0 -> 1.

6.4.5.2. Instance 21/71 - DeviceNet Standard (4 bytes, parameter $\text{C}203 = 1$)

Byte	Bit 7	Bit 6	Bit 5	Bit 4	Bit 3	Bit 2	Bit 1	Bit 0
0	-	Net Ref *	Net Ctrl *	-	-	Fault reset	Run Reverse	Run Forward
1	-							
2	Inverter Reference Speed min^{-1} (Low byte) **							
3	Inverter Reference Speed min^{-1} (High byte) **							

Fig. 3 Output Instance 21 Layout

Byte	Bit 7	Bit 6	Bit 5	Bit 4	Bit 3	Bit 2	Bit 1	Bit 0
0	At reference ***	Ref from Net ***	Ctrl from Net ***	Ready	Running Reverse	Running Forward	Warning	Faulted/tripped
1	Inverter Status ****							
2	Inverter Actual Speed min^{-1} (Low byte)							
3	Inverter Actual Speed min^{-1} (High byte)							

Fig. 4 Input Instance 71 Layout

* Bit 5 and 6 of Instance 21 byte 0 are defined as follows.

Bit 5 (Net Ctrl)..... When "1" is set, bits 0 (Run forward) and 1 (Run reverse) of byte 0 are enabled.
When "0" is set, Run/Stop is according to setup of the inverter parameter $\text{C}204$.

Bit 6 (Net Ref)..... When "1" is set, Inverter Reference Speed is according to the value of bytes 2 and 3.
When "0" is set, Inverter Reference Speed is according to setup of the inverter parameter $\text{F}204$.

** Inverter Reference Speed is set up number of rotations by the hexadecimal number.

For example, when "Frequency reference" is set up to 1800min^{-1} :
 $1800 = 0x0708$ (Hex.)

The rotational speed is converted to the frequency on the inverter side referring to a set value of parameter $\text{F}255$ (number of motor poles for the communication).

For example, if the parameter $\text{F}255 = 2$,
Output frequency = $1800 \times 2 / 60 = 60\text{Hz}$

In Input Instance, the frequency is converted to rotating speed and output by the inverter.

For example, if the parameter $\text{F}255 = 2$,
Output frequency = $60 / 2 \times 60 = 1800\text{min}^{-1}$

*** Bit 5, 6, and 7 of Instance 71 byte 0 are defined as follows.

Bit 5 (Ctrl from Net)..... When RUN/STOP command from DeviceNet is enabled, "1" is set.

Bit 6 (Ref from Net)..... When frequency command from DeviceNet is enabled, "1" is set.

Bit 7 (At reference)..... When output frequency becomes the same as frequency command, "1" is set.

**** Inverter Status is same as the Control Supervisor class State attribute (refer to section 6.7.2).

- 1 (00000001): Startup
- 2 (00000010): Not Ready
- 3 (00000011): Ready
- 4 (00000100): Enabled
- 5 (00000101): Stopping
- 6 (00000110): Fault Stop
- 7 (00000111): Faulted

Examples of Instance 21/71

① Stop

Instance	Byte	15	14	13	12	11	10	9	8	7	6	5	4	3	2	1	0	Hex.
Output Instance 21	1, 0	0	0	0	0	0	0	0	0	0	0	0	0	0	0	0	0	0x0000
	3, 2	-	-	-	-	-	-	-	-	-	-	-	-	-	-	-	-	-
Input Instance 71	1, 0	0	0	0	0	0	0	1	1	0	0	0	1	0	0	0	0	0x0310
	3, 2	0	0	0	0	0	0	0	0	0	0	0	0	0	0	0	0	0x0000

② Forward running 1800min⁻¹

Instance	Byte	15	14	13	12	11	10	9	8	7	6	5	4	3	2	1	0	Hex.
Output Instance 21	1, 0	0	0	0	0	0	0	0	0	0	1	1	0	0	0	0	1	0x0061
	3, 2	0	0	0	0	0	1	1	1	0	0	0	0	1	0	0	0	0x0708
Input Instance 71	1, 0	0	0	0	0	0	1	0	0	1	1	1	1	0	1	0	0	0x04F4
	3, 2	0	0	0	0	0	1	1	1	0	0	0	0	1	0	0	0	0x0708

③ Reverse running 1800min⁻¹

Instance	Byte	15	14	13	12	11	10	9	8	7	6	5	4	3	2	1	0	Hex.
Output Instance 21	1, 0	0	0	0	0	0	0	0	0	0	1	1	0	0	0	1	0	0x0062
	3, 2	0	0	0	0	0	1	1	1	0	0	0	0	1	0	0	0	0x0708
Input Instance 71	1, 0	0	0	0	0	0	1	0	0	1	1	1	1	1	0	0	0	0x04F8
	3, 2	0	0	0	0	0	1	1	1	0	0	0	0	1	0	0	0	0x0708

④ Fault reset *

Instance	Byte	15	14	13	12	11	10	9	8	7	6	5	4	3	2	1	0	Hex.
Output Instance 21	1, 0	0	0	0	0	0	0	0	0	0	0	0	0	0	1	0	0	0x0004
	3, 2	-	-	-	-	-	-	-	-	-	-	-	-	-	-	-	-	-

* Fault reset works only 1 time when 0 -> 1.

6.4.5.3. Instance 100/150 - Toshiba Specific (4 bytes, parameter $[203] = 2$)

Byte	Bit 7	Bit 6	Bit 5	Bit 4	Bit 3	Bit 2	Bit 1	Bit 0
0	DC braking	ACC1/ ACC2	PID control off	THR1,VF1/ THR2,VF2	Preset Speed4	Preset Speed3	Preset Speed2	Preset Speed1
1	Command link *	Frequency link *	Fault trip	Emergency stop	Coast stop command	Run/Stop	Forward/ Reverse	Jog run
2	Inverter Reference Speed Hz (Low byte) **							
3	Inverter Reference Speed Hz (High byte) **							

Fig. 5 Output Instance 100 Layout

Byte	Bit 7	Bit 6	Bit 5	Bit 4	Bit 3	Bit 2	Bit 1	Bit 0
0	DC braking	ACC1/ ACC2	PID control off	THR1,VF1/ THR2,VF2	Under voltage (<i>NOFF</i>)	ALARM (<i>FLG1</i>)	Failure	Failure FL
1	HAND/AUTO ****	Standby	Standby ST=ON	Emergency stop	Coast stop (ST off)	Run/Stop	Forward/ Reverse	Jog run
2	Inverter Actual Speed Hz (Low byte)							
3	Inverter Actual Speed Hz (High byte)							

Fig. 6 Input Instance 150 Layout

* Bit 7 and 6 of the instance 100 byte 1 are defined as follows.

Bit 7 (Command link) When "0" is set, the other command does not work except bit 4 and 3 of instance 100 byte 1, Run/Stop is according to setup of the inverter parameter $[NOd]$.

Bit 6 (Frequency link) When "1" is set, Inverter Reference Speed is according to the value of bytes 2 and 3.
When "0" is set, Inverter Reference Speed is according to setup of the inverter parameter $FNOd$.

** Inverter Reference Speed is set up by 0.01Hz unit and the hexadecimal number.

For example, when "Frequency reference" is set up to 60Hz, since the minimum unit is 0.01Hz, $60 / 0.01 = 6000 = 0x1770$ (Hex.)

*** About the detail of each function, refer to TOSVERT VF-AS3 RS485 communication manual.

**** Bit7(HAND/AUTO) is only VF-AS3.

Examples of Instance 100/150

① Stop

Instance	Byte	15	14	13	12	11	10	9	8	7	6	5	4	3	2	1	0	Hex.
Output Instance 100	1, 0	0	0	0	0	0	0	0	0	0	0	0	0	0	0	0	0	0x0000
	3, 2	-	-	-	-	-	-	-	-	-	-	-	-	-	-	-	-	-
Input Instance 150	1, 0	0	1	0	0	1	0	0	0	0	0	0	0	0	0	0	0	0x4800
	3, 2	0	0	0	0	0	0	0	0	0	0	0	0	0	0	0	0	0x0000

② Forward running 60Hz

Instance	Byte	15	14	13	12	11	10	9	8	7	6	5	4	3	2	1	0	Hex.
Output Instance 100	1, 0	1	1	0	0	0	1	0	0	0	0	0	0	0	0	0	0	0xC400
	3, 2	0	0	0	1	0	1	1	1	0	1	1	1	0	0	0	0	0x1770
Input Instance 150	1, 0	0	1	1	0	0	1	0	0	0	0	0	0	0	0	0	0	0x6400
	3, 2	0	0	0	1	0	1	1	1	0	1	1	1	0	0	0	0	0x1770

③ Reverse running 60Hz

Instance	Byte	15	14	13	12	11	10	9	8	7	6	5	4	3	2	1	0	Hex.
Output Instance 100	1, 0	1	1	0	0	0	1	1	0	0	0	0	0	0	0	0	0	0xC600
	3, 2	0	0	0	1	0	1	1	1	0	1	1	1	0	0	0	0	0x1770
Input Instance 150	1, 0	0	1	1	0	0	1	1	0	0	0	0	0	0	0	0	0	0x6600
	3, 2	0	0	0	1	0	1	1	1	0	1	1	1	0	0	0	0	0x1770

④ Preset speed 1 with forward running (f_r is 5Hz)

Instance	Byte	15	14	13	12	11	10	9	8	7	6	5	4	3	2	1	0	Hex.
Output Instance 100	1, 0	1	0	0	0	0	1	0	0	0	0	0	0	0	0	0	1	0x8401
	3, 2	-	-	-	-	-	-	-	-	-	-	-	-	-	-	-	-	-
Input Instance 150 (f_r is 5Hz.)	1, 0	0	1	1	0	0	1	0	0	0	0	0	0	0	0	0	0	0x6400
	3, 2	0	0	0	0	0	0	0	1	1	1	1	1	0	1	0	0	0x01F4

⑤ Fault reset *

Instance	Byte	15	14	13	12	11	10	9	8	7	6	5	4	3	2	1	0	Hex.
Output Instance 100	1, 0	0	0	1	0	0	0	0	0	0	0	0	0	0	0	0	0	0x2000
	3, 2	-	-	-	-	-	-	-	-	-	-	-	-	-	-	-	-	-

About the other command, refer to section 6.4.6.1..

* Fault reset works only 1 time when 0 -> 1.

6.4.5.4. Instance 101/151 - Toshiba Specific (8 bytes, parameter $\llcorner 203 = 3$)

Byte	Bit 7	Bit 6	Bit 5	Bit 4	Bit 3	Bit 2	Bit 1	Bit 0
0	-	Net Ref *	Net Ctrl *	-	-	Fault reset	Run reverse	Run forward
1	-							
2	Inverter Reference Speed min^{-1} (Low byte) **							
3	Inverter Reference Speed min^{-1} (High byte) **							
4	Index (Low byte)							
5	Write	Index (High byte)						
6	Data (Low byte)							
7	Data (High byte)							

Fig. 7 Output Instance 101 Layout

Byte	Bit 7	Bit 6	Bit 5	Bit 4	Bit 3	Bit 2	Bit 1	Bit 0
0	At reference ***	Ref from Net ***	Ctrl from Net ***	Ready	Running Reverse	Running Forward	Warning	Faulted/tripped
1	Inverter Status ****							
2	Inverter Actual Speed min^{-1} (Low byte)							
3	Inverter Actual Speed min^{-1} (High byte)							
4	Index (Low byte)							
5	Write	Error	Index (High byte)					
6	Data (Low byte)							
7	Data (High byte)							

Fig. 8 Input Instance 151 Layout

* Instance 101 byte 0, Bit 5 and 6 are defined as follows.

Bit 5 (Net Ctrl)When "1" is set, bits 0 (Run forward) and 1 (Run reverse) of byte 0 are enabled.
When "0" is set, Run/Stop is according to setup of the inverter parameter $\llcorner 00d$.

Bit 6 (Net Ref) When "1" is set, Inverter Reference Speed is according to the value of bytes 2 and 3.
When "0" is set, Inverter Reference Speed is according to setup of the inverter parameter $F00d$.

** Inverter Reference Speed is set up number of rotations by the hexadecimal number.

For example, when "Frequency reference" is set up to 1800min^{-1} :

$$1800 = 0x0708 \text{ (Hex.)}$$

The rotational speed is converted to the frequency on the inverter side referring to a set value of parameter $F856$ (number of motor poles for the communication).

For example, if the parameter $F856=2$,
Output frequency = $1800 \times 2 / 60 = 60\text{Hz}$

In Input Instance, the frequency is converted to rotating speed and output by the inverter.

For example, if the parameter $F856=2$,
Output frequency = $60 / 2 \times 60 = 1800 \text{ min}^{-1}$

*** Bit 5, 6, and 7 of the instance151 byte 0 are defined as follows.

Bit 5 (Ctrl from Net)..... When RUN/STOP command from DeviceNet is enabled, "1" is set.

Bit 6 (Ref from Net)..... When frequency command from DeviceNet is enabled, "1" is set.

Bit 7 (At reference)..... When output frequency becomes the same as frequency command, "1" is set.

**** Inverter Status is same as the Control Supervisor class State attribute (refer to 6.7.2).

- 1 (00000001): Startup
- 2 (00000010): Not Ready
- 3 (00000011): Ready
- 4 (00000100): Enabled
- 5 (00000101): Stopping
- 6 (00000110): Fault Stop
- 7 (00000111): Faulted

Examples of Instance 101/151

Access the inverter parameter is enabled using byte 4 to 7 of this Instance.

Set the communication number of the parameter to byte 4, 5 (Index), and the value to byte 6, 7 (Data).

① Read the parameter $\text{C} \overline{\text{P}} \overline{\text{D}}$ (Command mode selection, communication number is 0003).

Instance	Byte	15	14	13	12	11	10	9	8	7	6	5	4	3	2	1	0	Hex.
Output Instance 101	5, 4	0	0	0	0	0	0	0	0	0	0	0	0	0	0	1	1	0x0003
	7, 6	-	-	-	-	-	-	-	-	-	-	-	-	-	-	-	-	-
Input Instance 151 ($\text{C} \overline{\text{P}} \overline{\text{D}}$ is 0.)	5, 4	0	0	0	0	0	0	0	0	0	0	0	0	0	0	1	1	0x0003
	7, 6	0	0	0	0	0	0	0	0	0	0	0	0	0	0	0	0	0x0000

② Read the parameter $F \overline{2} \overline{5} \overline{B}$ (Initial value of UP/DOWN frequency).

Instance	Byte	15	14	13	12	11	10	9	8	7	6	5	4	3	2	1	0	Hex.
Output Instance 101	5, 4	0	0	0	0	0	0	1	0	0	1	1	0	1	0	0	0	0x0268
	7, 6	-	-	-	-	-	-	-	-	-	-	-	-	-	-	-	-	-
Input Instance 151 ($F \overline{2} \overline{5} \overline{B}$ is 60.0Hz.)	5, 4	0	0	0	0	0	0	1	0	0	1	1	0	1	0	0	0	0x0268
	7, 6	0	0	0	1	0	1	1	1	0	1	1	1	0	0	0	0	0x1770

③ Write “60 (Hz)” to the parameter $\overline{5} \overline{r} \overline{1}$ (Preset speed 1, communication number is 0018).

Instance	Byte	15	14	13	12	11	10	9	8	7	6	5	4	3	2	1	0	Hex.
Output Instance 101	5, 4	1	0	0	0	0	0	0	0	0	0	0	1	1	0	0	0	0x8018
	7, 6	0	0	0	1	0	1	1	1	0	1	1	1	0	0	0	0	0x1770
Input Instance 151 (OK)	5, 4	1	0	0	0	0	0	0	0	0	0	0	1	1	0	0	0	0x8018
	7, 6	0	0	0	1	0	1	1	1	0	1	1	1	0	0	0	0	0x1770
Input Instance 151 (NG) (Error code *)	5, 4	1	1	0	0	0	0	0	0	0	0	0	1	1	0	0	0	0xC018
	7, 6	0	0	0	1	0	0	0	1	0	0	0	0	0	0	0	1	0x1101

About byte 0 - 3, refer to section 6.4.5.2.

* Refer to following about the error code.

0x1100: Data out of range

0x1101: Bad address

6.4.5.5. Instance 102/152 - Toshiba Specific (12 bytes, parameter $\llcorner 203 = 4$)

Byte	Bit 7	Bit 6	Bit 5	Bit 4	Bit 3	Bit 2	Bit 1	Bit 0
0								$\llcorner 001$ Command data (Low byte)
1								$\llcorner 001$ Command data (High byte)
2								$\llcorner 002$ Command data (Low byte)
3								$\llcorner 002$ Command data (High byte)
4								$\llcorner 003$ Command data (Low byte)
5								$\llcorner 003$ Command data (High byte)
6								$\llcorner 004$ Command data (Low byte)
7								$\llcorner 004$ Command data (High byte)
8								$\llcorner 005$ Command data (Low byte)
9								$\llcorner 005$ Command data (High byte)
10								$\llcorner 006$ Command data (Low byte)
11								$\llcorner 006$ Command data (High byte)

Fig. 9 Output Instance 102 Layout

Byte	Bit 7	Bit 6	Bit 5	Bit 4	Bit 3	Bit 2	Bit 1	Bit 0
0								$\llcorner 021$ Monitor data (Low byte)
1								$\llcorner 021$ Monitor data (High byte)
2								$\llcorner 022$ Monitor data (Low byte)
3								$\llcorner 022$ Monitor data (High byte)
4								$\llcorner 023$ Monitor data (Low byte)
5								$\llcorner 023$ Monitor data (High byte)
6								$\llcorner 024$ Monitor data (Low byte)
7								$\llcorner 024$ Monitor data (High byte)
8								$\llcorner 025$ Monitor data (Low byte)
9								$\llcorner 025$ Monitor data (High byte)
10								$\llcorner 026$ Monitor data (Low byte)
11								$\llcorner 026$ Monitor data (High byte)

Fig. 10 Input Instance 152 Layout

About byte 0 - 11, refer to section 6.4.5.7.

6.4.5.6. Instance 105/155 - Toshiba Specific (18 bytes, parameter $\llbracket 203 \rrbracket = 5$)

Byte	Bit 7	Bit 6	Bit 5	Bit 4	Bit 3	Bit 2	Bit 1	Bit 0
0	-							
1	Function code (Read/Write command)* ¹							
2	Index (Low byte)							
3	Index (High byte)							
4	Data (Low byte)							
5	Data (High byte)							
6	$\llbracket 001 \rrbracket$ Command data (Low byte)							
7	$\llbracket 001 \rrbracket$ Command data (High byte)							
8	$\llbracket 002 \rrbracket$ Command data (Low byte)							
9	$\llbracket 002 \rrbracket$ Command data (High byte)							
10	$\llbracket 003 \rrbracket$ Command data (Low byte)							
11	$\llbracket 003 \rrbracket$ Command data (High byte)							
12	$\llbracket 004 \rrbracket$ Command data (Low byte)							
13	$\llbracket 004 \rrbracket$ Command data (High byte)							
14	$\llbracket 005 \rrbracket$ Command data (Low byte)							
15	$\llbracket 005 \rrbracket$ Command data (High byte)							
16	$\llbracket 006 \rrbracket$ Command data (Low byte)							
17	$\llbracket 006 \rrbracket$ Command data (High byte)							

Fig. 11 Output Instance 105 Layout

Byte	Bit 7	Bit 6	Bit 5	Bit 4	Bit 3	Bit 2	Bit 1	Bit 0
0	-							
1	Function code (Read/Write response)** ²							
2	Index (Low byte)							
3	Index (High byte)							
4	Data (Low byte)							
5	Data (High byte)							
6	$\llbracket 021 \rrbracket$ Monitor data (Low byte)							
7	$\llbracket 021 \rrbracket$ Monitor data (High byte)							
8	$\llbracket 022 \rrbracket$ Monitor data (Low byte)							
9	$\llbracket 022 \rrbracket$ Monitor data (High byte)							
10	$\llbracket 023 \rrbracket$ Monitor data (Low byte)							
11	$\llbracket 023 \rrbracket$ Monitor data (High byte)							
12	$\llbracket 024 \rrbracket$ Monitor data (Low byte)							
13	$\llbracket 024 \rrbracket$ Monitor data (High byte)							
14	$\llbracket 025 \rrbracket$ Monitor data (Low byte)							
15	$\llbracket 025 \rrbracket$ Monitor data (High byte)							
16	$\llbracket 026 \rrbracket$ Monitor data (Low byte)							
17	$\llbracket 026 \rrbracket$ Monitor data (High byte)							

Fig. 12 Input Instance 155 Layout

*1 About Read/Write command is followings.

Read the inverter parameter: 0x00

Write the inverter parameter: 0x80

*2 If Read/Write (Byte 1) is fault, set "1" to Input Instance 155 byte 1.

About byte 6 - 17, refer to section 6.4.5.7.

Examples of Instance 105/155

Access the inverter parameter is enabled using byte 1 to 5 of this Instance.

Set the communication number of the parameter to byte 2, 3 (Index), and the value to byte 4, 5 (Data).

① Read the parameter CND (Command mode selection, communication number is 0003).

Instance	Byte	15	14	13	12	11	10	9	8	7	6	5	4	3	2	1	0	Hex.
Output Instance 105	1, 0	0	0	0	0	0	0	0	0	0	0	0	0	0	0	0	0	0x0000
	3, 2	0	0	0	0	0	0	0	0	0	0	0	0	0	0	1	1	0x0003
	5, 4	-	-	-	-	-	-	-	-	-	-	-	-	-	-	-	-	-
Input Instance 155 (CND is 0.)	1, 0	0	0	0	0	0	0	0	0	0	0	0	0	0	0	0	0	0x0000
	3, 2	0	0	0	0	0	0	0	0	0	0	0	0	0	0	1	1	0x0003
	5, 4	0	0	0	0	0	0	0	0	0	0	0	0	0	0	0	0	0x0000

② Read the parameter $F25B$ (Initial value of UP/DOWN frequency).

Instance	Byte	15	14	13	12	11	10	9	8	7	6	5	4	3	2	1	0	Hex.
Output Instance 105	1, 0	0	0	0	0	0	0	0	0	0	0	0	0	0	0	0	0	0x0000
	3, 2	0	0	0	0	0	0	1	0	0	1	1	0	1	0	0	0	0x0268
	5, 4	-	-	-	-	-	-	-	-	-	-	-	-	-	-	-	-	-
Input Instance 155 ($F25B$ is 60.0Hz.)	1, 0	0	0	0	0	0	0	0	0	0	0	0	0	0	0	0	0	0x0000
	3, 2	0	0	0	0	0	0	1	0	0	1	1	0	1	0	0	0	0x0268
	5, 4	0	0	0	1	0	1	1	1	0	1	1	1	0	0	0	0	0x1770

③ Write "60 (Hz)" to the parameter $Sr1$ (Preset speed 1, communication number is 0018).

Instance	Byte	15	14	13	12	11	10	9	8	7	6	5	4	3	2	1	0	Hex.
Output Instance 105	1, 0	1	0	0	0	0	0	0	0	0	0	0	0	0	0	0	0	0x8000
	3, 2	0	0	0	0	0	0	0	0	0	0	0	1	1	0	0	0	0x0018
	5, 4	0	0	0	1	0	1	1	1	0	1	1	1	0	0	0	0	0x1770
Input Instance 155 (OK)	1, 0	0	0	0	0	0	0	0	0	0	0	0	0	0	0	0	0	0x0000
	3, 2	0	0	0	0	0	0	0	0	0	0	0	1	1	0	0	0	0x0018
	5, 4	0	0	0	1	0	1	1	1	0	1	1	1	0	0	0	0	0x1770
Input Instance 155 (NG) (Error code *)	1, 0	0	1	0	0	0	0	0	0	0	0	0	0	0	0	0	0	0x4000
	3, 2	0	0	0	0	0	0	0	0	0	0	0	1	1	0	0	0	0x0018
	5, 4	0	0	0	0	0	0	0	0	0	0	0	0	0	0	0	1	0x0001

*Data of "Error code"

0x0001: Error

6.4.5.7. How to use Instance 102/152, 105/155

The purposes of instances 102/152 (Byte 0 - 11) and 105/155 (Byte 6 - 17) are adjustment by real time command transmission, and the monitor of an operation state by using cyclic communication of DeviceNet.

Example 1: Command transmitting by the output Instance 102.

When you want to set "0xC400" to parameter *F A 0 6*, set "1 (*F A 0 6*)" to parameter *C 0 0 1*.
 And Since 0 and 1 byte of the output instance 102 supports the parameter *C 0 0 1*, if "0xC400" is set up here, "0xC400" will be set as *F A 0 6*.

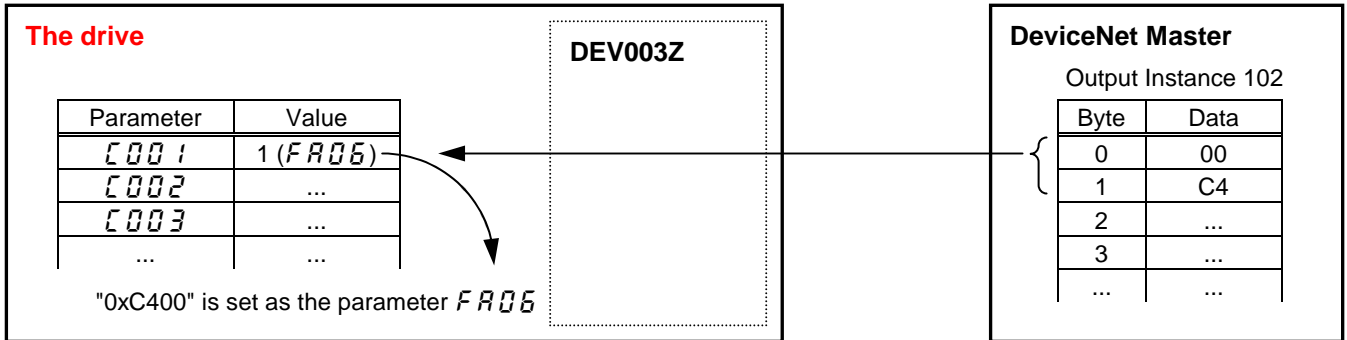

Example 2: State monitor by the input instance 152.

When you want to monitor the output current, set "3 (*F d 0 3*)" to parameter *C 0 2 1*.
 The value of the parameter *F d 0 3* specified as 0 and 1 byte of the input instance 152 with the parameter *C 0 2 1* is inputted.

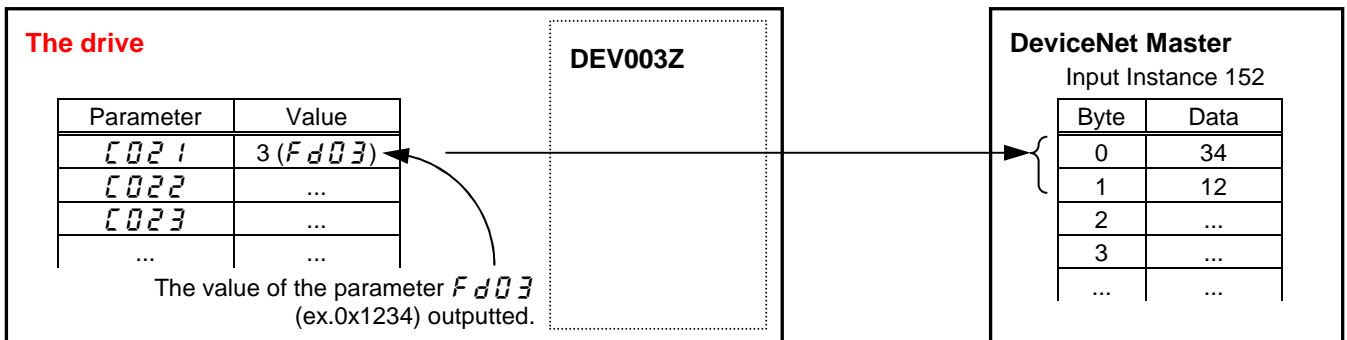

Monitor parameters for VF-MB1/S15

<i>C001 - C006</i> setup value	<i>C021 - C026</i> setup value
0: No action 1: <i>F A 0 6</i> (Communication command 1) 2: <i>F A 2 3</i> (Communication command 2) 3: <i>F A 0 7</i> (Frequency command, 0.01Hz) 5: <i>F A 5 0</i> (Terminal output data) 6: <i>F A 5 1</i> (FM analog output) 8: <i>F 6 0 1</i> (Stall prevention level, %) 13: <i>A C C</i> (Acceleration time 1, 0.1s) ^{*1} 14: <i>d E C</i> (Deceleration time 1, 0.1s) ^{*1} 15: <i>U L</i> (Upper limit, 0.01Hz) 16: <i>u b</i> (Torque boost value 1, 0.1%) 17: <i>u L u</i> (Base frequency voltage 1, 0.1V)	0: No action 1: <i>F d 0 1</i> (Status information 1) 2: <i>F d 0 0</i> (Output frequency, 0.01Hz) 3: <i>F d 0 3</i> (Output current, 0.01%) 4: <i>F d 0 5</i> (Output voltage, 0.01%) 5: <i>F C 9 1</i> (Alarm information) 6: <i>F d 2 2</i> (PID feedback value, 0.01Hz) 7: <i>F d 0 6</i> (Input terminal information) 8: <i>F d 0 7</i> (Output terminal information) 9: <i>F E 3 6</i> (VIB input value, 0.01%) 10: <i>F E 3 5</i> (VIA input value, 0.01%) 11: <i>F E 3 7</i> (VIC input value, 0.01%) 12: <i>F d 0 4</i> (Input voltage (DC detection), 0.01%) 13: <i>F d 1 6</i> (Estimated speed , 0.01Hz) 14: <i>F d 1 8</i> (Torque, 0.01%) 19: <i>F 8 8 0</i> (Free notes) 20: <i>F d 2 9</i> (Input power, 0.01kW) 21: <i>F d 3 0</i> (Output power, 0.01kW) 22: <i>F E 1 4</i> (Cumulative operation time, 1=1hour) 23: <i>F E 4 0</i> (FM terminal output monitor, 0.01%) 25: <i>F d 2 0</i> (Torque current, 0.01%) 26: <i>F d 2 3</i> (Motor overload factor, 0.01%) 27: <i>F d 2 4</i> (Inverter overload factor, 0.01%) 28: <i>F d 2 5</i> (PBR cumulative load factor, 1%) 29: <i>F d 2 6</i> (Motor load factor, 1%) 30: <i>F d 2 7</i> (Inverter load factor, 1%) 31: <i>F E 5 6</i> (Pulse train input value, pps) 32: <i>F E 7 0</i> (Rated current, 0.1A) 33: <i>F E 7 6</i> (Integral input power, 0.1kWh × 10 ^{F 749}) ^{*2} 34: <i>F E 7 7</i> (Integral output power, 0.1kWh × 10 ^{F 749}) ^{*2} 35: <i>F d 8 3</i> (IGBT temperature, degree C)

*1 The unit of *A C C*, *d E C* is according to the parameter *F 5 1 9*.

*2 The value of integral power can be calculated as "*F E 7 6* (or *F E 7 7*) * the rate from *F 7 4 9*".
 The unit of *F E 7 6*, *F E 7 7* is according to the parameter *F 7 4 9*.

Monitor parameters for VF-AS3

<i>C001 - C006</i> setup value	<i>C021 - C026</i> setup value
0: No action	0: No action
1: <i>F A 0 6</i> (Communication command 1)	1: <i>F d 0 1</i> (Status information 1)
2: <i>F A 2 3</i> (Communication command 2)	2: <i>F d 0 0</i> (Output frequency, 0.01Hz)
3: <i>F A 0 7</i> (Frequency command, 0.01Hz)	3: <i>F d 0 3</i> (Output current, 0.01%)
4: <i>F A 3 3</i> (Torque command 0.01%)	4: <i>F d 0 5</i> (Output voltage, 0.01%)
5: <i>F A 5 0</i> (Terminal output data)	5: <i>F C 9 1</i> (Inverter alarm)
6: <i>F A 5 1</i> (Analog output(FM) data from comm.)	6: <i>F d 2 2</i> (PID feedback value, 0.01Hz)
7: <i>F A 5 2</i> (Analog output(AM) data from comm.)	7: <i>F d 0 6</i> (Input terminal status)
8: <i>F 6 0 1</i> (Stall prevention level, %)	8: <i>F d 0 7</i> (Output terminal status)
9: <i>F 4 4 1</i> (Power running torque limit 1 level, 0.01%)	9: <i>F E 3 5</i> (RR input, 0.01%)
10: <i>F 4 4 3</i> (Regenerative braking torque limit 1 level, 0.01%)	10: <i>F E 3 6</i> (RX input, 0.01%)
11: <i>F 4 6 0</i> (Speed loop proportional gain)	11: <i>F E 3 7</i> (Ii input, 0.01%)
12: <i>F 4 6 1</i> (Speed loop stabilization coefficient)	12: <i>F d 0 4</i> (Input voltage (DC detection), 0.01%)
13: <i>A C C</i> (Acceleration time 1, 0.1s) (*1)	13: <i>F d 1 6</i> (Estimated speed (real-time value), 0.01Hz)
14: <i>d E C</i> (Deceleration time 1, 0.1s) (*1)	14: <i>F d 1 8</i> (Torque, 0.01%)
15: <i>U L</i> (Upper limit, 0.01Hz)	15: <i>F E 6 0</i> (My monitor)
16: <i>u b</i> (Torque boost value 1, 0.01%)	16: <i>F E 6 1</i> (My monitor)
17: <i>u L u</i> (Base frequency voltage 1, 0.1V)	17: <i>F E 6 2</i> (My monitor)
	18: <i>F E 6 3</i> (My monitor)
	19: <i>F 8 8 0</i> (Free notes)
	20: <i>F d 2 9</i> (Input power, 0.01kW)
	21: <i>F d 3 0</i> (Output power, 0.01kW)
	22: <i>F E 1 4</i> (Cumulative operation time, 1hour)
	23: <i>F E 4 0</i> (FM terminal output monitor, 0.01%)
	24: <i>F E 4 1</i> (AM terminal output monitor, 0.01%)
	25: <i>F d 2 0</i> (Torque current, 0.01%)
	26: <i>F d 2 3</i> (Motor overload factor, 0.01%)
	27: <i>F d 2 4</i> (Inverter overload factor, 0.01%)
	28: <i>F d 2 5</i> (PBR overload factor, %)
	29: <i>F d 2 6</i> (Motor load factor, %)
	30: <i>F d 2 7</i> (Inverter load factor, %)
	31: <i>F E 5 6</i> (Pulse train input, pps)
	32: <i>F E 7 0</i> (Inverter rated current, 0.1A)
	33: <i>F E 7 6</i> (Input Watt-hour, $0.1\text{kWh} \times 10^{F 749}$)
	34: <i>F E 7 7</i> (Output Watt-hour, $0.1\text{kWh} \times 10^{F 749}$)
	35: <i>F d 8 3</i> (IGBT temperature, degree C)

*1 The unit of *A C C*, *d E C* is according to the parameter *F 5 1 9*.

*2 The value of integral power can be calculated as "*F E 7 6* (or *F E 7 7*) * the rate from *F 7 4 9*".
The unit of *F E 7 6*, *F E 7 7* is according to the parameter *F 7 4 9*.

6.4.6. The outline of the parameter *C001-C006, C021-C026* setup value

The outline is indicated about the setting item of parameter *C001-C006* and *C021-C026* in Instance 102/152 and 105/155 of use.

Please refer to a communication functional description (E6581726/E6581913/E6582142) for details.

6.4.6.1. *FRQ6* (Communication command 1)

VF-MB1/S15

bit	Function	0	1	Note
0	Preset speed operation frequencies 1	0000*: Preset speed operation OFF 0001-1111: Setting of preset speed operation frequencies (1-15)		Preset speed operation is disabled or preset speed operation frequencies (1-15) are set by specifying bits for preset speed operation frequencies 1-15.
1	Preset speed operation frequencies 2			
2	Preset speed operation frequencies 3			
3	Preset speed operation frequencies 4			
4	Motor selection (1 or 2) (THR 2 selection)	Motor 1 (THR 1)	Motor 2 (THR 2)	THR 1: $Pt = \text{setting value, } uL, uLv, ub, tHr$ THR 2: $Pt = 0, F170, F171, F172, F173$
5	PI D control off	Normal operation	PID off	-
6	Acceleration/deceleration pattern selection (1 or 2) (AD2 selection)	Acceleration /deceleration pattern 1 (AD1)	Acceleration /deceleration pattern 2 (AD2)	AD1: <i>ACC, DEC</i> AD2: <i>F500, F501</i>
7	DC braking	OFF	Forced DC braking	-
8	Jog run	OFF	Jog run	-
9	Forward/reverse run selection	Forward run	Reverse run	-
10	Run/stop	Stop	Run	-
11	Coast stop command	Standby	Cost stop	-
12	Emergency stop	OFF	Emergency stop	Always enable, "E" trip
13	Fault reset	OFF	Reset	No data is returned from the inverter
14	Frequency priority selection	OFF	Enabled	Enabled regardless of the setting of <i>FNOd</i>
15	Command priority selection	OFF	Enabled	Enabled regardless of the setting of <i>CNOd</i>

* Frequency command set with *SR0* is valid when *FNOd*=14 (*SR0*).

SR0 is valid even when the command mode selection (*CNOd*) is not 0 (terminal block).

VF-AS3

bit	Function	0	1	Note
0	Preset speed switching 1	0000: Preset speed operation OFF (*1) 0001-1111: Setting of preset speed operation frequencies (1-15)		Preset speed operation is disabled or preset speed operation frequencies (1-15) are set by specifying bits for preset speed operation frequencies 1-4.
1	Preset speed switching 2			
2	Preset speed switching 3			
3	Preset speed switching 4			
4	V/f switching 1 (*2)	V/f 1	V/f 2	V/f 1: $P_t = \text{setting value, } uL, uL u, ub, tHrR$ V/f 2: $P_t = "0", F170, F171, F172, F182$
5	PID control	Normal operation	PID off	-
6	Acc/Dec switching 1 (*3)	AD mode 1	AD mode 2	AD mode 1: ACC, DEC AD mode 2: $F500, F501$
7	DC braking	OFF	Forced DC braking	-
8	Jog run	OFF	Jog run	-
9	Forward/Reverse	Forward run	Reverse run	-
10	Run/Stop	Stop	Run	-
11	Coast stop	Standby	Cost stop	-
12	Emergency off	OFF	Emergency off	Always enable, [E] trip
13	Fault reset	OFF	Reset	Trip reset
14	Frequency priority	OFF	Enabled	Enabled regardless of the setting of $FPOd$
15	Command priority	OFF	Enabled	Enabled regardless of the setting of $CPOd$

*1: When set "12(5r0)" to $FPOd$, preset speed operation frequency 0 is selected.

*2: The V/f switching ORs with Bit 10 of $[FR23]$.

*3: The Acc/Dec switching ORs with Bit 8 of $[FR23]$

6.4.6.2. *FA23* (Communication command 2)

VF-MB1/S15

bit	Function	0	1	Note
0	(Reserved)	-	-	-
1	Electric power quantity reset	OFF	Reset	Electric power quantity (<i>FE 76, FE 77</i>) reset
2	(Reserved)	-	-	-
3	(Reserved)	-	-	-
4	(Reserved)	-	-	-
5	(Reserved)	-	-	-
6	(Reserved)	-	-	-
7	Maximum deceleration forced stop	Normal	Enabled	-
8	Acceleration/deceleration selection 1	00: Acceleration/deceleration 1 01: Acceleration/deceleration 2 10: Acceleration/deceleration 3		Select acceleration/deceleration 1-4 by combination of two bits.. AD1: <i>ACC, DEC</i> AD2: <i>F500, F501</i> AD3: <i>F510, F511</i>
9	Acceleration/deceleration selection 2			
10	(Reserved)	-	-	-
11	(Reserved)	-	-	-
12	OC stall level switch	OC stall 1	OC stall 2	OC stall 1: <i>F601</i> OC stall 2: <i>F185</i>
13	(Reserved)	-	-	-
14	(Reserved)	-	-	-
15	(Reserved)	-	-	-

Note: Set 0 to reserved bits.

VF-AS3

bit	Function	0	1	Note
0	Control switching	Speed control	Torque control	-
1	Electric power quantity reset	OFF	Reset	Electric power quantity (FE76, FE77) reset
2	(Reserved)	-	-	-
3	Braking request (BC)	Normal	Forcibly braked	-
4	Preliminary excitation	Normal	Enabled	-
5	(Reserved)	-	-	-
6	Braking answer (BA)	Brake applied	Brake released	-
7	Quick deceleration 2	Normal	Enabled	-
8	Acc/dec switching 1 (*1)	00: AD mode 1 01: AD mode 2 10: AD mode 3 11: AD mode 4		Select Acc/Dec mode 1 - 4 by combination of two bits. AD mode 1: ACC, DEC AD mode 2: F500, F501 AD mode 3: F510, F511 AD mode 4: F514, F515
9	Acc/dec switching 2			
10	V/f switching 1 (*2)	00: V/f 1 01: V/f 2 10: V/f 3 11: V/f 4		Select V/f pattern 1 - 4 by combination of two bits V/f 1: $P_t = \text{setting value, } u_L, u_{L u}, u_b, t_{HrA}$ V/f 2: $P_t = "0", F170, F171, F172, F182$ V/f 3: $P_t = "0", F174, F175, F176, F183$ V/f 4: $P_t = "0", F178, F179, F180, F184$
11	V/f switching 2			
12	OC stall level switching and Torque limit switching 1	00: Torque limit 1 / OC stall 1 01: Torque limit 2 / OC stall 2 10: Torque limit 3 / OC stall 1 11: Torque limit 4 / OC stall 2		OC stall 1: F601 OC stall 2: F185 Select torque limit 1 - 4 by combination of two bits Torque limit 1: F441, F443 Torque limit 2: F444, F445 Torque limit 3: F446, F447 Torque limit 4: F448, F449
13	Torque limit switching 2			
14	Speed gain switching	Gain 1	Gain 2	Gain 1: F460, F461, F462 Gain 2: F463, F464, F465
15	(Reserved)	-	-	-

Note: Set 0 to reserved bit.

(*1): The Acc/Dec switching ORs with Bit 6 of [FA06]. When changing Acc/Dec in four types, set Bit 6 of [FA06] to "0" and use [FA23].

(*2): The V/f switching ORs with Bit 4 of [FA06]. When changing V/f in four types, set Bit 4 of [FA06] to "0" and use [FA23].

6.4.6.3. *F R Q 7* (Frequency command)

Frequency reference is set up by 0.01Hz unit and the hexadecimal number.

For example, when "Frequency reference" is set up to 80Hz, since the minimum unit is 0.01Hz,
 $80 / 0.01 = 8000 = 0x1F40$ (Hex.)

6.4.6.4. *F R 3 3* (Torque command) (VF-AS3)

Torque reference is set up by 0.01% unit and the hexadecimal number.

For example: when "torque command" is set up to "50%", since the minimum unit is 0.01%,
 $50\% = 50 \div 0.01 = 5000 = 1388H$

6.4.6.5. *F R 5 0* (Terminal output data)

By setting up the data of the bit 0 - 1 of terminal output data (*F R 5 0*) from communication, setting data (OFF or ON) can be outputted to the output terminal.

Please select the functional number 92 - 95 as the selection of the output terminal function parameter before using it.

bit	Output TB function name	0	1
0	Specified data output 1 (Output terminal No.: 92, 93)	OFF	ON
1	Specified data output 2 (Output terminal No.: 94, 95)	OFF	ON
2-15	(Reserved)	-	-

Note: Set 0 to reserved bit

6.4.6.6. *F R 5 1* (Terminal FM output data), *F R 5 2* (Terminal AM output data) (VF-AS3)

Use this function, set the Terminal FM function (*F R 5 1*) or Terminal AM function (*F R 5 2*) to communication data output (18 for VF-S15 / 31 for VF-AS3).

It possible to send out the data specified as FM/AM analog output data (*F R 5 1*/*F R 5 2*) though the FM/AM analog output terminal. Data can be adjusted in a range of 0 to 100.0% (resolution of 10 bit)..

Please refer to "Meter setting and adjustment" Section of the VF-S15/MB1 instruction manual for details.
 Please refer to "Adjusting the meter connected to the inverter" Section of the VF-AS3 instruction manual for more details.

6.4.6.7. *F 4 4 1* Power running torque limit level 1(VF-AS3), *F 4 4 3* Regenerative torque limit level 1(VF-AS3)

Torque limit level is set up by 0.01% unit and the hexadecimal number.

For example: when " Torque limit level " is set up to "250%", since the minimum unit is 0.01%,
 $250\% = 250 \div 0.01 = 25000 = 61A8H$

6.4.6.8. *F 4 6 0* Speed control response 1(VF-AS3)

Speed control response is set up by 0.01% unit and the hexadecimal number.

For example: when " Speed control response " is set up to "1.0%", since the minimum unit is 0.1%,
 $1\% = 1 \div 0.1 = 10 = 000AH$

6.4.6.9. *F45* : Speed control stabilization coefficient 1(VF-AS3)

Speed control stabilization coefficient is set up by 0.01% unit and the hexadecimal number.
 For example: when " Speed control stabilization coefficient " is set up to "1.00%", since the minimum unit is 0.01%,
 $1\% = 1 \div 0.01 = 100 = 0064H$

6.4.6.10. *Fd0* : (Status information 1 (real time))

VF-MB1/S15

bit	Function	0	1	Note
0	Failure FL	No output	Under in progress	-
1	Failure	Not tripped	Tripped	Trip status includes <i>rtr</i> and the trip retention statuses are also regarded as tripped statuses.
2	Alarm	No alarm	Alarm issued	When DeviceNet network is disconnected, this bit becomes "1".
3	Under voltage (<i>NOFF</i>)	Normal	Under voltage	-
4	Motor selection (1 or 2) (THR 2 selection)	Motor 1 (THR1)	Motor 2 (THR2)	THR1: $Pt = \text{setting value, } uL, uLu, ub, tHr$ THR2: $Pt = 0, F170, F171, F172, F173$
5	PID control off	PID control permitted	PID control prohibits	-
6	Acceleration/deceleration pattern selection (1 or 2)	Acceleration/deceleration pattern 1 (AD1)	Acceleration/deceleration pattern 2 (AD2)	AD1: <i>ACC, dec</i> AD2: <i>F500, F501</i>
7	DC braking	OFF	Forced DC braking	-
8	Jog run	OFF	Jog run	-
9	Forward/reverse run	Forward run	Reverse run	-
10	Run/stop	Stop	Run	-
11	Coast stop (ST = OFF)	ST=ON	ST=OFF	-
12	Emergency stop	No emergency stop status	Emergency stop status	-
13	Standby ST=ON	Start-up process	Standby	Standby: Initialization completed, not failure stop status, not alarm stop status (<i>NOFF, LL</i> forced stop), ST=ON, and RUN=ON
14	Standby	Start-up process	Standby	Standby: Initialization completed, not failure stop status, not alarm stop status (<i>NOFF, LL</i> forced stop)
15	(Undefined)	-	-	-

Note: The bit described "Undefined" is unstable. Don't use the bit for the judgment.

VF-AS3

bit	Function	0	1	Note
0	Failure FL	No output	Under in progress	-
1	Failure	Not tripped	Tripped	Trip status includes [r t r y] and the trip retention status is also regarded as tripped statuses.
2	Alarm	No alarm	Alarm issued	When DeviceNet network is disconnected, this bit becomes "1"
3	Under voltage ([MOFF])	Normal	Under voltage	-
4	V/f switching status	V/f 1	V/f 2	V/f 1: P t = setting value, u L, u L u, u b, t H r A V/f 2: P t = "0", F 170, F 171, F 172, F 182
5	PID control off	PID control permitted	PID control prohibits	-
6	Acc/Dec switching status	AD mode 1	AD mode 2	AD mode 1: A C C, d E C AD mode 2: F 500, F 501
7	DC braking	OFF	Forced DC braking	-
8	Jog run	OFF	Jog run	-
9	Forward / reverse run	Forward run	Reverse run	-
10	Run/stop	Stop	Run	-
11	Coast stop (ST = OFF)	ST=ON	ST=OFF	-
12	Emergency stop	No emergency stop status	Emergency stop status	-
13	Standby ST=ON	Start-up process	Standby	Standby: Initialization completed, not failure stop status, not alarm stop status (moff), [C O F F], [C O F F], [L S t P], ST =ON and RUN=ON
14	Standby	Start-up process	Standby	Standby: Initialization completed, not failure stop status and not alarm stop status ([MOFF], [C O F F], [C O F F], [L S t P])
15	HAND/AUTO (LOC/REM)	AUTO (LOC)	HAND (REM)	Enabled with [F 750]="2" HAND: Panel operation is enabled AUTO: Operation method selected [C N O d] and [F N O d] are enabled. Enabled with [F 732]="0" LOC: Panel operation is enabled REM: Operation method selected [C N O d] and [F N O d] are enabled.

Note: The bit described "Undefined" is unstable. Don't use the bit for the judgment.

6.4.6.11. F d 0 0 (Output frequency (real time))

The current output frequency is read into 0.01Hz of units and by the hexadecimal number. For example, when the output frequency is 80Hz, 0x1F40 (hexadecimal number) are read.

Since the minimum unit is 0.01%,
0x1F40 (Hex.) = 8000 (Dec.) * 0.01 = 80.00 (Hz)

Also about the following parameters, these are the same as this.

- F d 2 2 (Feedback value of PID (real time))..... Unit: 0.01Hz
- F d 1 6 (Estimated speed (real time)) Unit: 0.01Hz
- F d 2 9 (Input power (real time)) Unit: 0.01kW
- F d 3 0 (Output power (real time)) Unit: 0.01kW

6.4.6.12. *F d 0 3* (Output current (real time))

The output current is read into 0.01% of units and by the hexadecimal number.

For example, when the output current of the rated current 4.8A inverter is 50% (2.4A), 0x1388 (hexadecimal number) is read out.

Since the minimum unit is 0.01%,

$$0x1388 \text{ (Hex.)} = 5000 \text{ (Dec.)} * 0.01 = 50 \text{ (\%)}$$

Also about the following parameters, these are the same as this.

- *F d 0 5* (Output voltage (real time)) Unit: 0.01% (V)
- *F d 0 4* (Voltage at DC bus (real time)) Unit: 0.01% (V)
- *F d 1 8* (Torque) Unit: 0.01% (N·m)*

* 100% means the rated motor torque calculated by the motor constant parameters (*F 4 0 5* - *F 4 1 7*)

6.4.6.13. *F E 3 5*, *F E 3 6*, *F E 3 7* (Monitoring of the analog input)

VF-S15/MB1

VIA input value: "Communication Number *F E 3 5*"

VIB input value: "Communication Number *F E 3 6*"

VIC input value: "Communication Number *F E 3 7*"

These monitors can also be used as A/D converters irrespective of the inverter's control.

VIA / VIC input value monitor is capable of reading the data from external devices in a range of 0.00 to 100.00% (unsigned data: 0x0000 to 0x2710).

VIB input value monitor is capable of reading the data from external devices in a range of -100.00 to 100.00% (signed data: 0xD8F0 to 0x2710).

If analog input mode is selected with the frequency setting mode selection parameter, however, keep in mind that any data entered via an analog terminal is regarded as a frequency command.

VF-AS3

RR input value: "Communication Number *F E 3 5*"

RX input value: "Communication Number *F E 3 6*"

II input value : "Communication Number *F E 3 7*"

These monitors can also be used as A/D converters irrespective of the inverter's control.

RR / II input value monitor is capable of reading the data from external devices in a range of 0.00 to 100.00% (unsigned data: 0x0000 to 0x2710).

RX input value monitor is capable of reading the data from external devices in a range of -100.00 to 100.00% (signed data: 0xD8F0 to 0x2710).

If analog input mode is selected with the frequency setting mode selection parameter, however, keep in mind that any data entered via an analog terminal is regarded as a frequency command.

6.4.6.14. *F E 1 4* (Cumulative operation time)

The operated cumulative time is read by the hexadecimal number.

For example, when cumulative operation time is 18 hours, 0x12 (18 hours) is read.
0x12 (Hex.) = 18 (Dec., hour)

6.4.6.15. *F E 4 0* (FM terminal output monitor) , *F E 4 1* (AM output monitor) (VF-AS3)

The output value of FM/AM terminal is read.
The value range is set to 0 to 10000 (0x2710).

For example, when FM/AM output value is 50.00%, 0x1388 (Hex.) is read.
0x1388 (Hex) = 50.00 (Dec %)

* If the parameter *F 5 B 1* (Analog output) is set to 0, FM output monitor cannot be used.
Please set 1 or 2 to *F 5 B 1*.

6.4.6.16. *F C 9 I* (Alarm information)

VF-S15/MB1

bit	Function	0	1	Remarks (Code displayed on the panel)
0	Over-current alarm	Normal	Alarming	[<i>C</i>] flicking
1	Inverter overload alarm	Normal	Alarming	[<i>L</i>] flicking
2	Motor overload alarm	Normal	Alarming	[<i>L</i>] flicking
3	Overheat alarm	Normal	Alarming	[<i>H</i>] flicking
4	Overvoltage alarm	Normal	Alarming	[<i>P</i>] flicking
5	Undervoltage alarm	Normal	Alarming	-
6	Main module overload alarm	Normal	Alarming	[<i>L</i>] flicking
7	Low current alarm	Normal	Alarming	-
8	Over-torque alarm	Normal	Alarming	-
9	Braking resistor overload alarm	Normal	Alarming	-
10	Cumulative operation hours alarm	Normal	Alarming	-
11	DEV003Z communication alarm	Normal	Alarming	[<i>t</i>] flicking
12	Serial communication alarm	Normal	Alarming	[<i>t</i>] flicking
13	Main-circuit voltage error alarm	Normal	Alarming	[<i>NOFF</i>] flicking
14	Regenerative power ride-through control	-	Decelerating, stopping	[<i>StOP</i>] flicking
15	Stop at lower-limit frequency operation (sleep function)	-	Decelerating, stopping	[<i>StOP</i>] flicking

VF-AS3

bit	Function	0	1	Panel display
0	Overcurrent alarm	Normal	Alarming	[<i>C</i>] flicking
1	Inverter over load alarm	Normal	Alarming	[<i>L</i>] flicking
2	Motor over load alarm	Normal	Alarming	[<i>L</i>] flicking
3	Overheat alarm	Normal	Alarming	[<i>H</i>] flicking
4	Overvoltage alarm	Normal	Alarming	[<i>P</i>] flicking
5	(Undefined)	-	-	-
6	Inverter overheat alarm	Normal	Alarming	[<i>L</i>] flicking
7	Undercurrent alarm	Normal	Alarming	-
8	Overtorque alarm	Normal	Alarming	-
9	Braking resistor overload alarm	Normal	Alarming	-
10	Cumulative run time alarm	Normal	Alarming	-
11	Communication option alarm	Normal	Alarming	[<i>t</i>] flicking
12	Serial communication alarm	Normal	Alarming	[<i>t</i>] flicking
13	Power circuit under voltage alarm	Normal	Alarming	[<i>NOFF</i>] flicking
14	Stop after instantaneous power off	-	Dec., Under stop	[<i>StOP</i>] flicking
15	During sleep	-	Dec., Under stop	[<i>StOP</i>] flicking

6.4.6.17. *F 105* (Input terminal information)

VF-S15/MB1

bit	TB Name	Function (Parameter)	0	1
0	F	<i>F 111</i> : Input terminal function selection 1	OFF	ON
1	R	<i>F 112</i> : Input terminal function selection 2		
2	RES	<i>F 113</i> : Input terminal function selection 3		
3	S1	<i>F 114</i> : Input terminal function selection 4		
4	S2	<i>F 115</i> : Input terminal function selection 5		
5	S3* ¹	<i>F 116</i> : Input terminal function selection 6		
6	VIB* ²	<i>F 117</i> : Input terminal function selection 7		
7	VIA* ²	<i>F 118</i> : Input terminal function selection 8		
8 - 15	(Undefined)	-	-	-

Note: The bit described "Undefined" is unstable. Do not use the bit for the judgment.

*1: Only when the contact input has been selected with *F 147* (Logic input / PTC input selection (S3)), it is an effective value.

*2: Only when the contact input has been selected with *F 109* (Analog/logic input selection (VIA/VIB)), it is an effective value.

*The input terminal function is selected by each parameter.

VF-AS3

bit	TB Name	Function (Parameter)	0	1
0	F	<i>F 111</i> : Input terminal function selection 1	OFF	ON
1	R	<i>F 112</i> : Input terminal function selection 2		
2	RES	<i>F 113</i> : Input terminal function selection 3		
3	S1	<i>F 114</i> : Input terminal function selection 4		
4	S2	<i>F 115</i> : Input terminal function selection 5		
5	S3	<i>F 116</i> : Input terminal function selection 6		
6	S4* ¹	<i>F 117</i> : Input terminal function selection 7		
7	S5* ²	<i>F 118</i> : Input terminal function selection 8		
8	DI11* ³	<i>F 119</i> : Input terminal function selection 9		
9	DI12* ³	<i>F 120</i> : Input terminal function selection 10		
10	DI13* ³	<i>F 121</i> : Input terminal function selection 11		
11	DI14* ³	<i>F 122</i> : Input terminal function selection 12		
12	DI15* ³	<i>F 123</i> : Input terminal function selection 13		
13	DI16* ³	<i>F 124</i> : Input terminal function selection 14		
14 to 15	(Undefined)	-	-	-

Note: The bit described "Undefined" is unstable. Do not use the bit for the judgment.

*1: Only when the contact input has been selected with *F 147* (Digital/ Pulse train/PG input), it is an effective value.

*2: Only when the contact input has been selected with *F 148* (Digital/ Pulse train/PG input), it is an effective value.

*3: DI11 – DI16 are the terminals of I/O extension.

6.4.6.18. *F_{d07}* (Output terminal information)**VF-S15/MB1**

bit	TB Name	Function (Parameter)	0	1
0	RY-RC	Output terminal function selection 1 (<i>F 130</i>)	OFF	ON
1	OUT	Output terminal function selection 2 (<i>F 131</i>)	OFF	ON
2	FL	Output terminal function selection 3 (<i>F 132</i>)	OFF	ON
3 - 15	(Undefined)	-	-	-

Note: The bit described "Undefined" is unstable. Do not use the bit for the judgment.

VF-AS3

bit	TB Name	Function (Parameter)	0	1
0	FP	<i>F 130</i> : Terminal FP function 1	OFF	ON
1	(Undefined)	-	-	-
2	FL	<i>F 132</i> : Terminal FL function	OFF	ON
3	R1	<i>F 133</i> : Terminal R1 function 1	OFF	ON
4	R2	<i>F 134</i> : Terminal R2 function	OFF	ON
5	DQ11 ^{*1}	<i>F 159</i> : Terminal DQ11 function	OFF	ON
6	DQ12 ^{*1}	<i>F 160</i> : Terminal DQ12 function	OFF	ON
7	R4 ^{*1}	<i>F 161</i> : Terminal R4 function	OFF	ON
8	R5 ^{*1}	<i>F 162</i> : Terminal R5 function	OFF	ON
9	R6 ^{*1}	<i>F 163</i> : Terminal R6 function	OFF	ON
10	R4(B) ^{*1}	<i>A201</i> : Terminal R4 (B) function	OFF	ON
11	R5(B) ^{*1}	<i>A202</i> : Terminal R5 (B) function	OFF	ON
12	R6(B) ^{*1}	<i>A203</i> : Terminal R6 (B) function	OFF	ON
13 to 15	(Undefined)	-	-	-

Note: The bit described "Undefined" is unstable. Do not use the bit for the judgment.

*1: DQ11, DQ12, R4, R5, R6, R4 (B), R5(B) and R6(b) are the terminals of I/O extension.

6.4.6.19. Instance 106/156 - Toshiba Specific (8 bytes, parameter $\llbracket 203 \rrbracket = 6$) (Only VF-AS3)

This instance is implemented for only VF-AS3.

Byte	Bit 7	Bit 6	Bit 5	Bit 4	Bit 3	Bit 2	Bit 1	Bit 0
0	-	Net Ref *	Net Ctrl *	-	-	Fault reset	Run reverse	Run forward
1	Write	-						
2	Inverter Reference Speed min^{-1} (Low byte) **							
3	Inverter Reference Speed min^{-1} (High byte) **							
4	Index (Low byte)							
5	Index (High byte)							
6	Data (Low byte)							
7	Data (High byte)							

Fig. 13 Output Instance 106 Layout

Byte	Bit 7	Bit 6	Bit 5	Bit 4	Bit 3	Bit 2	Bit 1	Bit 0
0	At reference ***	Ref from Net ***	Ctrl from Net ***	Ready	Running Reverse	Running Forward	Warning	Faulted/tripped
1	Write	Error	Inverter Status ****					
2	Inverter Actual Speed min^{-1} (Low byte)							
3	Inverter Actual Speed min^{-1} (High byte)							
4	Index (Low byte)							
5	Index (High byte)							
6	Data (Low byte)							
7	Data (High byte)							

Fig. 14 Input Instance 156 Layout

* Instance 101 byte 0, Bit 5 and 6 are defined as follows.

Bit 5 (Net Ctrl) When "1" is set, bits 0 (Run forward) and 1 (Run reverse) of byte 0 are enabled.
When "0" is set, Run/Stop is according to setup of the inverter parameter $\llbracket n0d \rrbracket$.

Bit 6 (Net Ref) When "1" is set, Inverter Reference Speed is according to the value of bytes 2 and 3.
When "0" is set, Inverter Reference Speed is according to setup of the inverter parameter $F n0d$.

** Inverter Reference Speed is set up number of rotations by the hexadecimal number.

For example, when "Frequency reference" is set up to 1800min^{-1} :

$$1800 = 0x0708 \text{ (Hex.)}$$

The rotational speed is converted to the frequency on the inverter side referring to a set value of parameter $F 856$ (number of motor poles for the communication).

For example, if the parameter $F 856 = 2$,
Output frequency = $1800 \times 2 / 60 = 60\text{Hz}$

In Input Instance, the frequency is converted to rotating speed and output by the inverter.

For example, if the parameter $F 856 = 2$,
Output frequency = $60 / 2 \times 60 = 1800 \text{ min}^{-1}$

*** Bit 5, 6, and 7 of the instance151 byte 0 are defined as follows.

Bit 5 (Ctrl from Net)..... When RUN/STOP command from DeviceNet is enabled, "1" is set.

Bit 6 (Ref from Net)..... When frequency command from DeviceNet is enabled, "1" is set.

Bit 7 (At reference)..... When output frequency becomes the same as frequency command, "1" is set.

**** Inverter Status is same as the Control Supervisor class State attribute (refer to 6.7.2).

- 1 (00000001): Startup
- 2 (00000010): Not Ready
- 3 (00000011): Ready
- 4 (00000100): Enabled
- 5 (00000101): Stopping
- 6 (00000110): Fault Stop
- 7 (00000111): Faulted

6.5. Connection Object

Class code 0x05. The Connection Class allocates and manages the internal resources associated with both I/O and Explicit Messaging Connections.

6.5.1. Connection Object Attributes

Attribute ID	Name	Data Type	Access Rules	Description	Default Value
1	Revision	UINT	Get	Revision of this object.	1
2	Max Instance	UINT	Get	Maximum instance number of an object currently created in this class level of the device	-

6.5.2. Connection Object Instance Attributes

Connection Instance ID #	Description
1	References the Explicit Messaging Connection (refer to 6.5.2.1).
2	Reference the Polled I/O Connection (refer to 6.5.2.3).
4	Reference the COS/Cyclic Connection (refer to 6.5.2.5).

6.5.2.1. Explicit Messaging Connection Object Instance Attributes (Instance 1)

Attribute ID	Name	Data Type	Access Rules	Description	Default Value
1	State	USINT	Get	State of the object 00 = Non-existent 01 = Configuring 02 = Waiting for connection ID 03 = Established 04 = Timed Out 05 = Deferred Delete	3
2	Instance type	USINT	Get	Indicates connection type	0 (Explicit Message)
3	TransportClass trigger	USINT	Get	Connection behavior	0x83 (Server Transport Class 3)
4	Produced connection id	UINT	Get	Placed in CAN ID field when transmitting	-
5	Consumed connection id	UINT	Get	CAN ID field value denoting received messages	-
6	Initial comm characteristics	USINT	Get	Defines producing / consuming message groups	0x21 (Send: Gr. 2) (Resp: Gr. 2)
7	Produced connection size	UINT	Get	Max number of bytes transmitted across this connection	39
8	Consumed connection size	UINT	Get	Max number of bytes received across this connection	39
9	Expected packet rate	UINT	Get/Set	Defines timing associated with this connection (ms).	- *
12	Watchdog timeout action	USINT	Get/Set	Inactivity/watchdog timeout action	1 (Auto Delete)
13	Produced connection path length	UINT	Get	Number of bytes in Produced connection path attribute	0
14	Produced connection path	ARRAY of USINT	Get	Specifies Application Object(s) whose data is to be produced by this connection	Empty
15	Consumed connection path length	UINT	Get	Number of bytes in Consumed connection path attribute	0
16	Consumed connection path	ARRAY of USINT	Get	Specifies Application Object(s) whose data is to be consumed by this connection	Empty
18	Connection timeout multiplier	USINT	Get/Set	Specifies the multiplier (4×2^n) applied to the Expected packet rate value for calculate the Inactivity/Watchdog timer. Setting range: n=0-7 (8 or more are reserved.)	0

* Attribute 9 Expected packet rate is set by the master at communication start.

6.5.2.2. Connection Class Common Services

Service Code	Service Name	Supported		Description of Service
		Class	Instance	
0x05	Reset	N/A	Yes	Used to reset all resettable connection objects.
0x0E	Get Attribute Single	Yes	Yes	Returns the contents of the specified attribute.
0x10	Set Attribute Single	N/A	Yes	Modifies the value of the specified attribute.

6.5.2.3. Poll Connection Object Instance Attributes (Instance 2)

Attribute ID	Name	Data Type	Access Rules	Description	Default Value
1	State	USINT	Get	Indicates the Poll Connection Object is in the Configuring state. 00 = Non-existent 01 = Configuring 02 = Waiting for connection ID 03 = Established 04 = Timed Out 05 = Deferred Delete	-
2	Instance type	USINT	Get	Indicates connection type	1 (I/O)
3	TransportClass trigger	USINT	Get	Connection behavior	0x82 (Server Transport Class 2)
4	Produced connection id	UINT	Get	Placed in CAN ID field when transmitting	-
5	Consumed connection id	UINT	Get	CAN ID field value denoting received messages	-
6	Initial comm characteristics	USINT	Get	Defines producing / consuming message groups	0x1 (Send: Gr. 1) (Resp: Gr. 2)
7	Produced connection size	UINT	Get	Max number of bytes transmitted across this connection	4
8	Consumed connection size	UINT	Get	Max number of bytes received across this connection	4
9	Expected packet rate	UINT	Get/Set	Defines timing associated with this connection	.*
12	Watchdog timeout action	USINT	Get	Inactivity/watchdog timeout action	0 (Timed Out)
13	Produced connection path length	UINT	Get	Number of bytes in Produced connection path attribute	7
14	Produced connection path	ARRAY of USINT	Get	Specifies Application Object(s) whose data is to be produced by this connection	0x20 0x04 0x25 0x46 0x00 0x30 0x03 (Instance 70)
15	Consumed connection path length	UINT	Get	Number of bytes in Consumed connection path attribute	7
16	Consumed connection path	ARRAY of USINT	Get	Specifies Application Object(s) whose data is to be consumed by this connection	0x20 0x04 0x25 0x14 0x00 0x30 0x03 (Instance 20)
17	Production inhibit time	UINT	Get	Defines minimum time between new data production	0
18	Connection multiplier timeout	USINT	Get/Set	Specifies the multiplier (4×2^n) applied to the Expected packet rate value for calculate the Inactivity/Watchdog timer. Setting range: n=0-7 (8 or more are reserved.)	0

* Attribute 9 Expected packet rate is set by the master at communication start.

6.5.2.4. Connection Class Common Services

Service Code	Service Name	Supported		Description of Service
		Class	Instance	
0x05	Reset	Yes	Yes	Used to reset all resettable connection objects.
0x0E	Get Attribute Single	Yes	Yes	Returns the contents of the specified attribute.
0x10	Set Attribute Single	N/A	Yes	Modifies the value of the specified attribute.

6.5.2.5. COS/Cyclic Connection Object Instance Attributes (Instance 4)

Attribute ID	Name	Data Type	Access Rules	Description	Default Value
1	State	USINT	Get	State of the object 00 = Non-existent 01 = Configuring 02 = Waiting for connection ID 03 = Established 04 = Timed Out 05 = Deferred Delete	-
2	Instance type	USINT	Get	Indicates connection type	1 (I/O)
3	TransportClass trigger	USINT	Get	Connection behavior	0x12 [Client Transport Class 2]
4	Produced connection id	UINT	Get	Placed in CAN ID field when transmitting	-
5	Consumed connection id	UINT	Get	CAN ID field value denoting received messages	-
6	Initial comm characteristics	USINT	Get	Defines producing / consuming message groups	0x01 [Send: Gr. 1 Resp: Gr. 2]
7	Produced connection size	UINT	Get	Max number of bytes transmitted across this connection	4
8	Consumed connection size	UINT	Get	Max number of bytes received across this connection	0
9	Expected packet rate	UINT	Get/Set	Defines timing associated with this connection (ms).	- *
12	Watchdog timeout action	USINT	Get	Inactivity/watchdog timeout action	0 (Timed Out)
13	Produced connection path length	UINT	Get	Number of bytes in Produced connection path attribute	7
14	Produced connection path	ARRAY of USINT	Get	Specifies Application Object(s) whose data is to be produced by this connection	0x20 0x04 0x25 0x46 0x00 0x30 0x03 [Instance 70]
15	Consumed connection path length	UINT	Get	Number of bytes in Consumed connection path attribute	5
16	Consumed connection path	ARRAY of USINT	Get	Specifies Application Object(s) whose data is to be consumed by this connection	0x20 0x2B 0x25 0x01 0x00
17	Production inhibit time	UINT	Get/Set	Defines minimum time between new data production	0
18	Connection timeout multiplier	USINT	Get/Set	Specifies the multiplier (4×2^n) applied to the Expected packet rate value for calculate the Inactivity/Watchdog timer. Setting range: n=0-7 (8 or more are reserved.)	0

* Attribute 9 Expected packet rate is set by the master at communication start.

6.5.2.6. Connection Class Common Services

Service Code	Service Name	Supported		Description of Service
		Class	Instance	
0x05	Reset	Yes	Yes	Used to reset all resettable connection objects.
0x0E	Get Attribute Single	Yes	Yes	Returns the contents of the specified attribute.
0x10	Set Attribute Single	N/A	Yes	Modifies the value of the specified attribute.

6.6. Motor Data Object

Class code 0x28. This object serves as a database for motor parameters.

6.6.1. Motor Data Object Class Attributes

Attribute ID	Name	Data Type	Access Rules	Description	Default Value
1	Revision	UINT	Get	Revision of this object	1
2	Max Instance	UINT	Get	Maximum instance number of an object currently created in this class level of the device	1
6	Maximum ID Number Class Attributes	UINT	Get	The attribute ID number of the last class attribute of the class definition implemented in the device.	7
7	Maximum ID Number Instance Attributes	UINT	Get	The attribute ID number of the last instance attribute of the class definition implemented in the device.	15

6.6.2. Motor Data Object Instance Attributes

Attribute ID	Name	Data Type	Access Rules	Description	Default Value
1	NumAttr	USINT	Get	Number of Attributes supported	9
2	Attributes	ARRAY of USINT	Get	List of attributes supported	-
3	MotorType	USINT	Get	0 - Non-standard motor 1 - PM DC Motor 2 - FC DC Motor 3 - PM Synchronous Motor 4 - FC Synchronous Motor 5 - Switched Reluctance Motor 6 - Wound Rotor Induction Motor 7 - Squirrel Cage Induction Motor 8 - Stepper Motor 9 - Sinusoidal PM BL Motor 10 - Trapezoidal PM BL Motor	7
6	RatedCurrent	UINT	Get/Set	Rated Stator Current [100mA]	-
7	RatedVoltage	UINT	Get/Set	Rated Base Voltage Units [V]	-
8	RatedPower	UDINT	Get/Set	Rated Power at Rated Freq Units [W]	-
9	RatedFreq	UINT	Get/Set	Rated Electrical Frequency Unit [Hz]	-
12	PoleCount	UINT	Get	Number of poles in the motor	-
15	BaseSpeed	UINT	Get/Set	Nominal speed at rated frequency from nameplate Units [min^{-1}]	-

6.6.3. Motor Data Object Common Services

Service Code	Service Name	Supported		Description of Service
		Class	Instance	
0x0E	Get Attribute Single	N/A	Yes	Returns the contents of the specified attribute.
0x10	Set Attribute Single	N/A	Yes	Modifies the value of the specified attribute.

6.6.4. Motor Data Object Specific Services

Motor Data Object provides no object specific services.

Notes

▼ When you use this command, the value is written to the EEPROM.

6.7. Control Supervisor Object

Class code 0x29. This object models all the management functions for devices within the DeviceNet "Hierarchy of Motor Control Devices". The behavior of motor control devices is described by the State Transition Diagram.

6.7.1. Control Supervisor Object Class Attributes

Attribute ID	Name	Data Type	Access Rules	Description	Default Value
1	Revision	UINT	Get	Revision of this object	1
2	Max Instance	UINT	Get	Maximum instance number of an object currently created in this class level of the device	1
6	Maximum ID Number Class Attributes	UINT	Get	The attribute ID number of the last class attribute of the class definition implemented in the device.	7
7	Maximum ID Number Instance Attributes	UINT	Get	The attribute ID number of the last instance attribute of the class definition implemented in the device.	15

6.7.2. Control Supervisor Object Instance Attributes

Attribute ID	Name	Data Type	Access Rules	Description	Default Value
1	NumAttr	USINT	Get	Number of Attributes supported	13
2	Attributes	ARRAY of USINT	Get	List of attributes supported	-
3	Run 1	BOOL	Get/Set	See Run/Stop Event Matrix (refer to 6.7.5) 0 = Stop 1 = Run	-
4	Run 2	BOOL	Get/Set	See Run/Stop Event Matrix 0 = Stop 1 = Run	-
5	NetCtrl	BOOL	Get/Set	Requests Run/Stop control to be local or from network. 0 = Local Control 1 = Network Control Note that the actual status of Run/Stop control is reflected in attribute 15, CtrlFromNet.	-
6	State	USINT	Get	0 = Vendor Specific 1 = Startup 2 = Not_Ready 3 = Ready 4 = Enabled 5 = Stopping 6 = Fault_Stop 7 = Faulted	-
7	Running 1	BOOL	Get	1 = (Enabled and Run1) or (Stopping and Running1) or (Fault_Stop and Running1) 0 = Other state	-
8	Running 2	BOOL	Get	1 = (Enabled and Run2) or (Stopping and Running2) or (Fault_Stop and Running2) 0 = Other state	-
9	Ready	BOOL	Get	1 = Ready or Enabled or Stopping 0 = Other state	-
10	Faulted	BOOL	Get	1 = Fault Occurred (latched) 0 = No Faults present	-
11	Warning	BOOL	Get	1 = Warning (not latched) 0 = No Warnings present	-
12	FaultRst	BOOL	Get/Set	0->1 = Fault Reset 0 = No action	-
15	CtrlFromNet	BOOL	Get	Status of Run/Stop control source. 0 = Control is local 1 = Control is from network	-

6.7.3. Control Supervisor Object Common Services

Service Code	Service Name	Supported		Description of Service
		Class	Instance	
0x05	Reset	N/A	Yes	Used to reset all resettable connection objects.
0x0E	Get Attribute Single	N/A	Yes	Returns the contents of the specified attribute.
0x10	Set Attribute Single	N/A	Yes	Modifies the value of the specified attribute.

6.7.4. Control Supervisor Object Specific Services

The Control Supervisor Object provides no object specific services.

6.7.5. Run/Stop Event Matrix

Run1	Run2	Trigger Event	Run Type
0	0	Stop	No Action
0 -> 1	0	Run	Run1
0	0 -> 1	Run	Run2
0 -> 1	0 -> 1	No Action	No Action
1	1	No Action	No Action
1 -> 0	1	Run	Run2
1	1 -> 0	Run	Run1

6.7.6. Control Supervisor State Transition Diagram

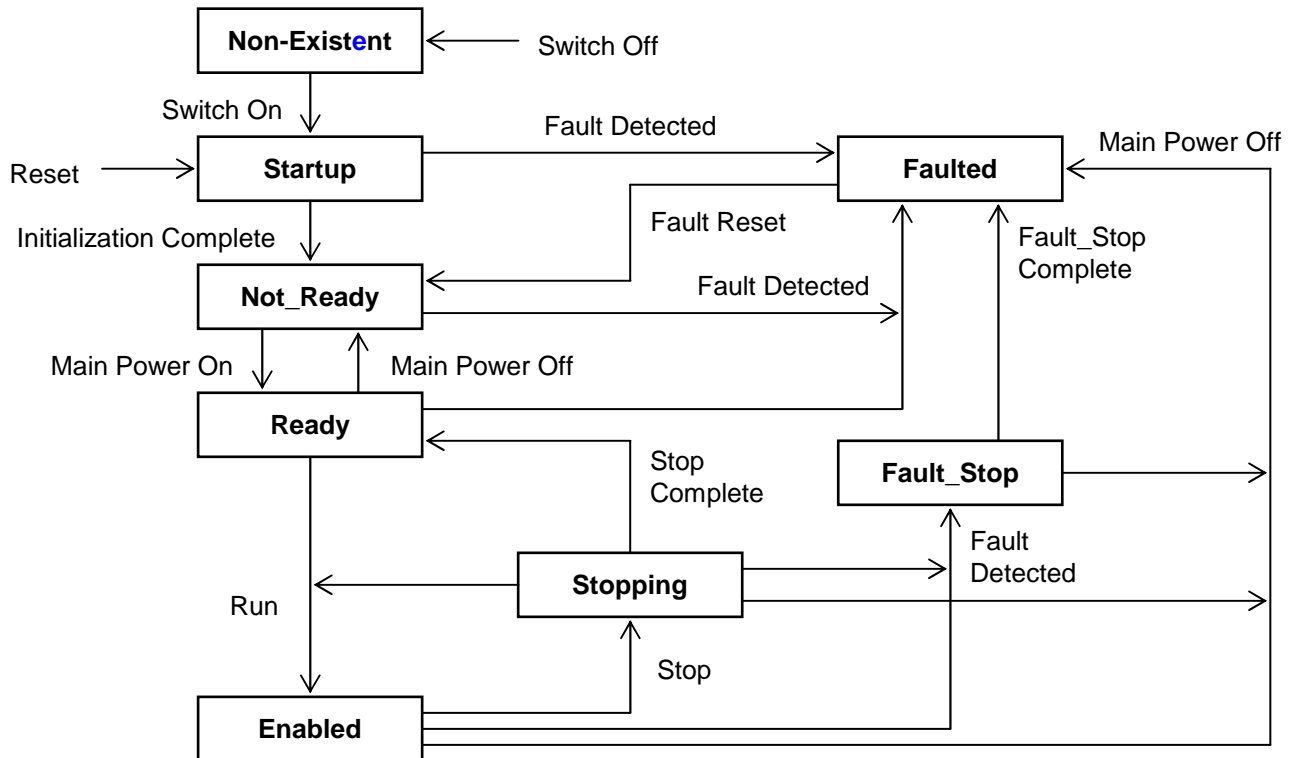

6.8. AC/DC Drive Object

Class code 0x2A. This object models the functions specific to an AC or DC Drive. e.g. speed ramp, torque control etc.

6.8.1. AC/DC Drive Object Class Attributes

Attribute ID	Name	Data Type	Access Rules	Description	Default Value
1	Revision	UINT	Get	Revision of this object	1
2	Max Instance	UINT	Get	Maximum instance number of an object currently created in this class level of the device	1
6	Maximum ID Number Class Attributes	UINT	Get	The attribute ID number of the last class attribute of the class definition implemented in the device.	7
7	Maximum ID Number Instance Attributes	UINT	Get	The attribute ID number of the last instance attribute of the class definition implemented in the device.	46

6.8.2. AC/DC Drive Object Instance Attributes

Attribute ID	Name	Data Type	Access Rules	Description	Default Value
1	NumAttr	USINT	Get	Number of Attributes supported	19
2	Attributes	ARRAY of USINT	Get	List of Attributes supported	-
3	AtReference	BOOL	Get	1 = Drive actual at reference (speed or torque reference) based on mode	-
4	NetRef	BOOL	Get/Set	Requests torque or speed reference to be local or from network. 0 = Set Reference not DN Control 1 = Set Reference at DN Control Note that the actual status of torque or speed reference is reflected in attribute 29, RefFromNet.	-
6	DriveMode	USINT	Get	0 = Vendor specific mode 1 = Open loop speed (Frequency) 2 = Closed loop speed control 3 = Torque control 4 = Process control (e.g. PI) 5 = Position control	-
7	SpeedActual	INT	Get	Actual drive speed (best approximation) Units: min ⁻¹	-
8	SpeedRef	INT	Get/Set	Speed reference Units: min ⁻¹	-
9	CurrentActual	INT	Get	Actual motor phase current Units: 100mA	-
10	CurrentLimit	INT	Get/Set	Motor phase current limit Units: 100mA	-
11	TorqueActual	INT	Get	Actual torque Units: N·m	-
15	PowerActual	INT	Get	Actual output power Units: W/2 ^{PowerScale}	-
18	AccelTime	UINT	Get/Set	Acceleration time Time from 0 to HighSpdLimit Units: ms/2 ^{TimeScale}	-
19	DecelTime	UINT	Get/Set	Acceleration time Time from HighSpdLimit to 0 Units: ms/2 ^{TimeScale}	-
20	LowSpdLimit	UINT	Get/Set	Minimum speed limit Units: min ⁻¹	-
21	HighSpdLimit	UINT	Get/Set	Maximum speed limit Units: min ⁻¹	-
26	PowerScale	SINT	Get/Set	Power scaling factor.	0
28	TimeScale	SINT	Get/Set	Time scaling factor.	0
29	RefFromNet	BOOL	Get	Status of torque/speed reference 0 = Local torque/speed reference 1 = DeviceNet torque/speed reference	-
46	Drive On Hours	DINT	Get	Number of hours Units: h	-

6.8.3. AC/DC Drive Object Common Services

Service Code	Service Name	Supported		Description of Service
		Class	Instance	
0x0E	Get Attribute Single	Yes	Yes	Returns the contents of the specified attribute.
0x10	Set Attribute Single	N/A	Yes	Modifies the value of the specified attribute.

6.8.4. AC/DC Drive Object Specific Services

AC/DC Drive Object provides no object specific services for the slave.

Notes

▼ When you use this command, the value is written to the EEPROM.

6.9. Acknowledge Handler Object

Class code 0x2B. This object is used to manage the reception of message acknowledgements. This object communicates with a message producing Application Object within a device.

6.9.1. Acknowledge Handler Object Class Attributes

Attribute ID	Name	Data Type	Access Rules	Description	Default Value
1	Revision	UINT	Get	Revision of this object	1
2	Max Instance	UINT	Get	Maximum instance number of an object currently created in this class level of the device	1

6.9.2. Acknowledge Handler Object Instance Attributes

Attribute ID	Name	Data Type	Access Rules	Description	Default Value
1	Acknowledge Timer	UINT	Get/Set	Time to wait for acknowledge before resending	(16)
2	Retry Limit	USINT	Get/Set	Number of Ack Timeouts to wait before informing the producing application of a Retry Limit Reached event.	1
3	COS Producing Connection Instance	UINT	Get	Connection Instance which contains the path of the producing I/O application object which will be notified of Ack Handler events.	(Connection Instance ID)

6.9.3. Acknowledge Handler Object Common Services

Service Code	Service Name	Supported		Description of Service
		Class	Instance	
0x0E	Get Attribute Single	Yes	Yes	Returns the contents of the specified attribute.
0x10	Set Attribute Single	N/A	Yes	Modifies the value of the specified attribute.

6.9.4. Acknowledge Handler Object Specific Services

Acknowledge Handler Object provides no object specific services.

6.10. Parameter Object (Vender Specific Profiles)

This object provides the inverter parameter access.

Class code: 0x65.

Inverter parameter's Attribute ID is 3, the inverter parameter number is set as Instance ID.

For example, in case of set 5 sec. to "Acc. time", the minimum unit of "Acc. time" is 0.1 sec., the set value is

$$5 / 0.1 = 50 = 0x0032 \text{ (Hex.)}$$

And the communication number of "Acc. time" is "0009".

So, set the value 0x0032 to Class 0x65, Instance 0009, Attribute 3 to use Set Single Attribute service.

* Parameter *RU1* can not be accessed by using Class 0x65. Please, use Class 0x64.

Class code: 0x64.

Also, Class 0x64 at the previous model is supported. All parameter's Attribute ID is 3.

The instance ID should be set "VF-MB1 or VF-S15 parameter communication number + 0x4000".

In the case of the parameter from which a communication number begins in "F", it should be set "the inverter parameter communication number - 0x8000 (same as bit 15 set to 0)".

Example 1.

In case of Basic parameter "*EN00* - Command mode selection",
Communication No: 0003 -> Instance ID: 4003

Example 2.

In case of Extended parameter "*F300* - PWM carrier frequency",
Communication No: 0300 -> Instance ID: 4300

Example 3.

In case of Monitor parameter "*FE03* - Output current",
Communication No: FE03 -> Instance ID: 7E03

* Monitor parameter can access "Get" only.

Notes

- ▼ When you use this command, the value is written to the EEPROM.

CAUTION



Prohibited

- ▼ Do not use application of writing into inverter parameters more than 100,000 times.
The Life of EEPROM is approximately 100,000 times.
Frequent writing to the EEPROM of inverter will cause a memory corruption.

7. DeviceNet Local/Remote Operation

The example below shows how to configure the the for local / remote operation.

Exsample: VF-S15/MB1

<Terminalboard function>

- F terminal RUN command
- R terminal..... DeviceNet /Local (Terminal in this example) switching
- VIA terminal..... Operation frequency command

<Wiring>

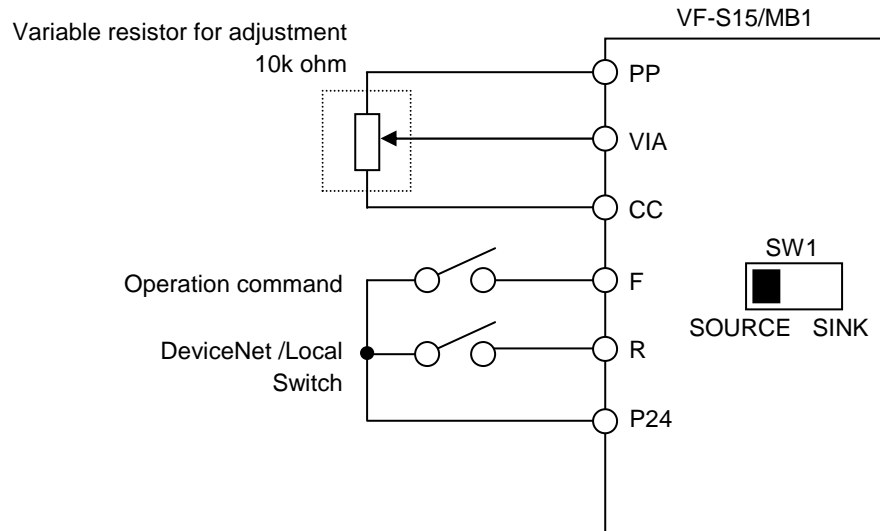

<Parameter setting>

- CMD (command mode selection) = 0 (terminal board)
- FSD (frequency setting mode selection 1) = 1 (VIA)
- $F12$ (input terminal selection 2 (R)) = 48 (DeviceNet/Local control)

<Operation>

- R-P24 terminal open:
VF-S15/MB1 is controlled as slave device of DeviceNet.
- R-P24 terminal closed:
F-P24 terminal short to RUN
F-P24 terminal open to STOP
Output frequency is set up by the VIA signal input.

Exsample: VF-AS3

<Terminalboard function>

- F terminal RUN command
- R terminal DeviceNet /Local (Terminal in this example) switching
- RR terminal Operation frequency command

<Wiring>

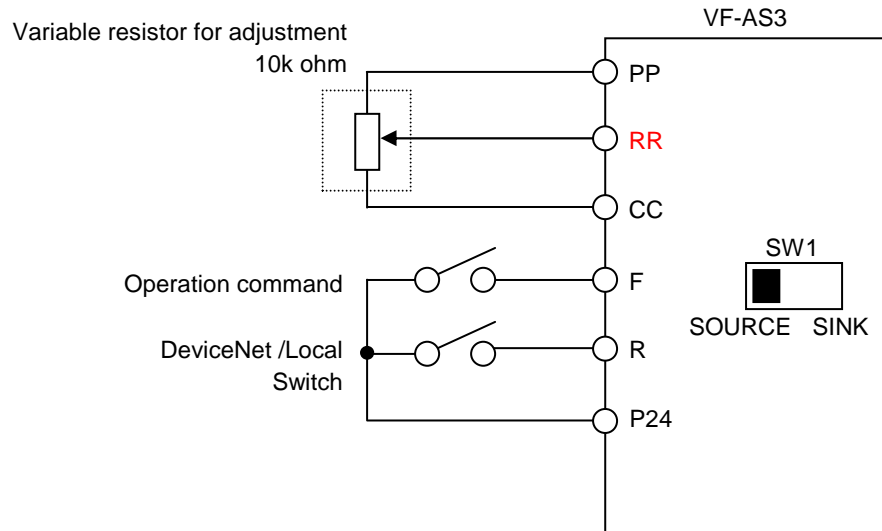

<Parameter setting>

- $F10d$ (command mode selection) = 0 (terminal board)
- $F11d$ (frequency setting mode selection 1) = 1 (RR)
- $F12$ (input terminal selection 2 (R)) = 48 (DeviceNet/Local control)

<Operation>

- R-P24 terminal open:
VF-AS3 is controlled as slave device of DeviceNet.
 - R-P24 terminal closed:
F-P24 terminal short to RUN
F-P24 terminal open to STOP
- Output frequency is set up by the RR signal input.

8. EDS File

Even if access to each parameter of the inverter uses a configuration tool and an EDS file, it is possible. As for acquisition of an EDS file, please contact your Toshiba distributor.

Please use what was in agreement with the software version of usage's the inverter.

9. Specifications

Item	Specifications	
Type-Form	DEV003Z	
DeviceNet Specification	Device Type	AC drive
	DeviceNet power consumption	Input Voltage:11 to 25Vdc Consumption current: 60mA (24Vdc).
	Indicator	MS (Module status) NS (Network status)
	Connector	Open type screw connector (Plug type)
	Instance	20/70, 21/71 (DeviceNet spec.) 100/150, 101/151, 102/152, 105/155, 106/156* *Instance 106/156 is for VF-AS3 only. (Vendor spec.) Setup by inverter parameter $\llcorner 203$.
	MAC ID setup	0-63 *Setup by inverter parameter $\llcorner 200$.
	Baud rate setup	Setup by inverter parameter $\llcorner 201$.
	Baud rate	125kbps, 250kbps, 500kbps
	Response time	About 5ms (Cyclic) About 10ms (Explicit)
Vendor ID	377	
Weight	0.1kg	
Location of use	Indoors, an altitude of 3,000m or less, where the product will not be exposed to direct sunlight, corrosive or explosive gases, vapor, coarse particulates including dust, and where there is no grinding fluid or grinding oil nearby	
Ambient temperature	-10 to +60°C	
Storage temperature	-25 to +70°C	
Relative humidity	5 to 95% (no condensation and absence of vapor)	
Vibration	5.9m/s ² {0.6G} or less (10 - 55Hz)	