



SYNCHRONGENERATOREN

ECP 28 4 C

Technical Guide

General Data

Standards

Alternators are designed and produced within an ISO 9001 environment. The entire series is manufactured according to, and complies with, the most common specifications such as CEI 2-3, IEC 34-1, EN 60034-1, VDE 0530, BS 4999-5000, NF 51.111, CAN/CSA-C22.2 No14-95-No100-95, NEMA MG 1-2011, ISO 8528-3. Other standards such as UL1446, UL 1004/4 and /B are available on request.

Windings and Performances

All windings are 2/3rds pitch to eliminate triplen harmonics within the voltage waveform and to avoid excessive neutral currents in certain parallel operating conditions. A fully interconnected aluminium or copper damper cage is supplied on the rotor of all models (excluding the ECP3 series).

- ▶ 12 wire reconnectable:
 - 50Hz – 380V to 440V and 220/110V to 240/120V (de-rates may apply at certain voltages)
 - 60Hz – 380V to 480V and 220/110V to 240/120V (de-rates may apply at certain voltages)
- ▶ 6 wire reconnectable:
 - 50Hz – 380V to 440V and 220V to 240V (de-rates may apply at certain voltages)
 - 60Hz – 380V to 480V and 220V to 240V (de-rates may apply at certain voltages)

Winding Configurations	Standard		Special (dedicated)			
	12 wire Reconnectable	6 wire Reconnectable	380V and 600V 60Hz	690V 50/60Hz	220-240V 1ph 50Hz	220-240V 1ph 60Hz
ECP3 to ECO38	Std	Option	Option	Option	Option	Option
ECO40 to ECO46	Std	Option	Option	Option	Option (to ECO40)	Option (to ECO40)
Insulation materials	Class H	Class H	Class H	Class H	Class H	Class H
High efficiency	Std	Std	Std	Std	Std	Std
High motor starting	>300%	>300%	>300%	>300%	>300%	>300%
THD (Total Harmonic Distortion)	Typically <3.5% full load L-L	Typically <3.0% full load L-L	Typically <3.5% full load L-L	Typically <3.5% full load L-L	Typically <4.5% full load L-N	Typically <4.5% full load L-N
Interference suppression	VDE 0875 G/N/K, EN61000-6-3, EN61000-6-2, others available on request					

Winding Protection

There are various degrees of protection for the windings following the standard impregnation process, as can be seen here. The TOTAL+ butadienic black flexible coating is recommended for arduous applications.

Winding Protection:	STANDARD	STANDARD+	GREY	GREY+	TOTAL+ (3% de-rate may apply on certain models)
ECP3	Std	Option	Option	Option	Option
ECP28 and ECP32	-	Std	Option	Option	Option
NPE32, ECP34 to ECO46	-	-	Std	Option	Option

General Data

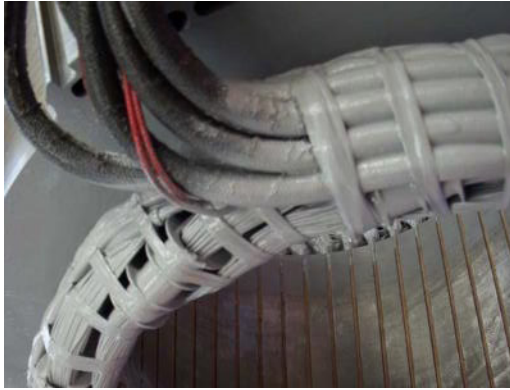

Grey treatment (marinization) on the left, TOTAL+ treatment shown on the right. The EG43 grey varnish, is an high temperature insulating enamel that forms a tough and flexible film, with excellent moisture and chemical protection. It is water and oil proof, and also protects windings from abrasion. It is applied spraying an over coating layer over the impregnated winding, or dipping the stator in a varnish barrel for superior treatments

The TOTAL+ is a protection system that makes special. It is the ultimate winding treatment that offers truly superior performances when the environment is really harsh, or the application very demanding. It is a rubbery protection treatment, used to replace epoxies and silicones winding encapsulation. The TOTAL+ flexible black compound cures to a tough, resilient, glossy black thick coating that seals the copper against moisture and chemical attacks. Due to its encapsulation capability and flexibility, is also extremely resistant to the particle abrasion as it adsorbs the impacts. Moreover, the high flexibility leads to a long-trouble less life protection, as the compound follows elastically the thermal expansion cycles of the windings from the cold to the hot condition and vice versa without forming any cracks.

Protection for Environment

In addition to protection on the windings themselves, the alternators can have increased ingress protection. Standard levels are IP23 with further upgrades available to include inlet filters, IP43 and IP45: 7% de-rates apply on inlet filters and IP43 protection. 20-30% de-rates apply for IP45 depending on alternator model.

Additional air exit louvres (called IP23+) are optionably retrofittable in the overall ECP32 to ECO 46 range, in order to comply to the most strict marine regulations.



Construction

The robust mechanical structure withstands up to 5G in any direction and 9G vertically and its design permits easy access to the connections and components during routine maintenance check-ups. The mechanical design has used the most advanced FEM techniques. The materials used are: FEPI2 steel for the frame, C45 steel for the shaft and cast iron or aluminum pressure die cast for the end-brackets: fans are aluminum die casted either nylon fiber glass loaded, UL compliant materials. Rotors are dynamically balanced according grade 2.5 of ISO 1940-1.

General Data

Terminals and Terminal Box

Easy access to regulators is assured through a pull out drawer or a drop down panel to allow safer adjustment. Large terminal boxes allow easy access of power cables, in the ECO43 and ECO46 higher power ranges the terminal allow the convenient choice of power cable or busbar connection with versatility of entry and connection. Current transformers are available as an option on series ECO 40, 43 and 46 with single or dual output.

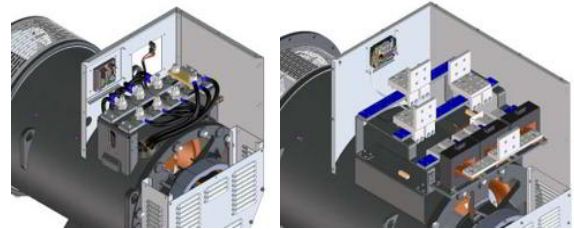

Excitation and Regulation Systems

All ECP/ECO series have MAUX auxiliary winding to power the digital regulator. Both DSR and the DER1 are available to connect to PC through the DxR2 USB interface and DxR TERMINAL software to interrogate/download alarms & settings for analysis or for cloning other regulators. DER2 has got an integrated USB connection and can be connected to the PC without any optional connection boards. More settings such as LAMS, digital RAM based synchronous external control and soft start are obtainable through the DxR connection. Simple analogue potentiometers are available for the more usual adjustments.

Excitation Systems	DSR	DER1	DER2
ECP3 to ECO38	Std	Option	Option
ECO40 to ECO46	-	Std	Option
Parallel Operation	√	√	√
Mains Parallel	√	√	√
3 Phase Sensing (rms)	-	√	√
Accuracy	+/-1%	+/-0.5%	+/-0.5%
Remote Voltage Control	√	√	√
Alarm Log	√	√	√
Analogue and Digital Configurable	√	√	√
LAMS (Load Acceptance V/f)	√	√	√
APO (Active Protection Output)	√	√	√
Soft Start	√	√	√
High dynamic response	-	-	√
USB connection without external boards	-	-	√

For a given motor start duty a smaller machine may be selected – also enhanced by low sub-transient reactance values for non-linear loads. The whole range from 6.5 to 3400kVA is capable of >300% sustained short circuit current for up to 20 seconds.

General Data

Optional PMG3

PMG3 can be retro fit or factory fit on ECO 40, 43 and 46 series. This smart design allows an easy fix kit, through a tapered cone coupling and a simple replacement of the rear air louvre. PMG3 is also available on ECO 38, when ordered from the factory.

The complete AVR range is fully compatible with both MAUX and PMG3 systems, this minimises spare part management and flexibility of stock as one AVR suits all applications. The PMG3 is delivering the same amount of kVA available with the MAUX.

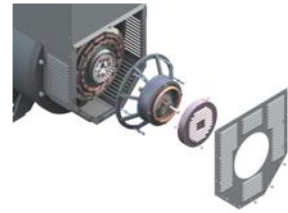

Accessories

Additional optionals can be fit on our alternator series, such as PTC thermistors or PT100 both on windings and bearings, space heaters, high and low profile of terminal boxes (on most series), air filter clogging sensors, rotating diode bridge failure sensor (RBD), power factor controller for parallel operation (PFR/2), parallel devices (standard from ECO 40), air filters, IP43 and IP45 protections, marine IP23 + protection for SOLAS requirements and many others.

Deration coefficients

Altitude (meters)	Ambient temperature (Celsius)					
	25	40	45	50	55	60
≤ 1000	1.07	1	0.96	0.93	0.91	0.89
$> 1000 \leq 1500$	1.01	0.96	0.92	0.89	0.87	0.84
$> 1500 \leq 2000$	0.96	0.91	0.87	0.84	0.83	0.79
$> 2000 \leq 3000$	0.9	0.85	0.81	0.78	0.76	0.73

Notes on short circuit curves

The indicated coefficients have to be used to correct the three phase short circuit curves values as a function of the rated voltage.

The indicated coefficient have to be used to correct the three phase short circuit curves values as a function of the type of short circuit voltage.

50 Hz		60 Hz	
Voltage	Factor	Voltage	Factor
380	0.93X	415	0.85X
400	1X	440	0.90X
415	1.04X	460	0.95X
440	1.10X	480	1X

	3 phase	2 phase L-L	1 phase L-N
<i>Istantaneous</i>	1X	0.87X	1.30X
<i>Minimum</i>	1X	1.80X	3.20X
<i>Sustained</i>	1X	1.50X	2.50X
<i>Max Duration</i>	20 sec.	10 sec.	4 sec.

All the curves are shown for series or parallel star connection at 400V 50 Hz or 480V 60 Hz. If the unit is reconnected from series to parallel star, the additional coefficient is 2X. From series star to series delta, it is 1.72X. From series star to parallel delta, it is 3.44X.

ECP28 4 C

General characteristics

Pole number	4	Insulation class	H
Phase number	3	Protection class	IP23
Number of wires	12	NDE Bearing type	6207-2RS
Execution	Brushless	DE Bearing type	6309-2RS
Regulator type	DSR	Maximum Overspeed	2250
Winding pitch	2/3	Altitude	0-1000
Code voltage reference	T0405S3	Balancing	ISO1940-1

Ratings 50Hz

kVA / kW @ Temp. Rise / Ambient °C - 0.8 PF																					
		STANDBY-163/27				STANDBY-150/40				H-125/40				F-105/40				B-80/40			
Series Star Y		380V	400V	415V	440V	380V	400V	415V	440V	380V	400V	415V	440V	380V	400V	415V	440V	380V	400V	415V	440V
Parallel Star YY		190V	200V	208V	220V	190V	200V	208V	220V	190V	200V	208V	220V	190V	200V	208V	220V	190V	200V	208V	220V
Series Delta Δ		220V	230V	240V	254V	220V	230V	240V	254V	220V	230V	240V	254V	220V	230V	240V	254V	220V	230V	240V	254V
Parallel Delta ΔΔ		110V	115V	120V	127V	110V	115V	120V	127V	110V	115V	120V	127V	110V	115V	120V	127V	110V	115V	120V	127V
ECP28 1V54 C	kVA	8,2	8,2	8,2	-	7,7	7,7	7,7	-	7,5	7,5	7,5	-	6,7	6,7	6,7	-	6	6	6	-
	kW	6,6	6,6	6,6	-	6,2	6,2	6,2	-	6	6	6	-	5,4	5,4	5,4	-	4,8	4,8	4,8	-
ECP28 2V54 C	kVA	11	11	11	-	10,3	10,3	10,3	-	10	10	10	-	9,1	9,1	9,1	-	8	8	8	-
	kW	8,8	8,8	8,8	-	8,2	8,2	8,2	-	8	8	8	-	7,3	7,3	7,3	-	6,4	6,4	6,4	-
ECP28 1S4 C	kVA	13,7	13,7	13,7	-	13	13	13	-	12,5	12,5	12,5	-	11,6	11,6	11,6	-	10	10	10	-
	kW	11	11	11	-	10,4	10,4	10,4	-	10	10	10	-	9,3	9,3	9,3	-	8	8	8	-
ECP28 2S4 C	kVA	16,5	16,5	16,5	-	15,4	15,4	15,4	-	15	15	15	-	14,1	14,1	14,1	-	12	12	12	-
	kW	13,2	13,2	13,2	-	12,4	12,4	12,4	-	12	12	12	-	11,3	11,3	11,3	-	9,6	9,6	9,6	-
ECP28 3S4 C	kVA	19,2	19,2	19,2	17,5	18	18	18	16,5	17,5	17,5	17,5	16	16,5	16,5	16,5	14,9	14	14	14	12,8
	kW	15,4	15,4	15,4	14	14,4	14,4	14,4	13,2	14	14	14	12,8	13,2	13,2	13,2	11,9	11,2	11,2	11,2	10,2
ECP28 M4 C	kVA	22	22	22	20,4	20,5	20,5	20,5	19	20	20	20	18,5	18,5	18,5	18,5	17,5	16	16	16	14,8
	kW	17,6	17,6	17,6	16,3	16,4	16,4	16,4	15,2	16	16	16	14,8	14,8	14,8	14,8	14	12,8	12,8	12,8	11,9
ECP28 L4 C	kVA	27,5	27,5	27,5	-	25,5	25,5	25,5	-	25	25	25	-	23	23	23	-	20	20	20	-
	kW	22	22	22	-	20,4	20,4	20,4	-	20	20	20	-	18,4	18,4	18,4	-	16	16	16	-
ECP28 VL4 C	kVA	33	33	33	-	30,5	30,5	30,5	-	30	30	30	-	26	26	26	-	24	24	24	-
	kW	26,4	26,4	26,4	-	24,4	24,4	24,4	-	24	24	24	-	20,8	20,8	20,8	-	19,2	19,2	19,2	-

Ratings 60Hz

kVA / kW @ Temp. Rise / Ambient °C - 0.8 PF																					
		STANDBY-163/27				STANDBY-150/40				H-125/40				F-105/40				B-80/40			
Series Star Y		415V	440V	460V	480V	415V	440V	460V	480V	415V	440V	460V	480V	415V	440V	460V	480V	415V	440V	460V	480V
Parallel Star YY		208V	220V	230V	240V	208V	220V	230V	240V	208V	220V	230V	240V	208V	220V	230V	240V	208V	220V	230V	240V
Series Delta Δ		240V	254V	265V	277V	240V	254V	265V	277V	240V	254V	265V	277V	240V	254V	265V	277V	240V	254V	265V	277V
Parallel Delta ΔΔ		120V	127V	133V	138V	120V	127V	133V	138V	120V	127V	133V	138V	120V	127V	133V	138V	120V	127V	133V	138V
ECP28 1V54 C	kVA	8,8	9,3	9,9	9,9	8,3	8,7	9,3	9,3	8	8,5	9	9	7,2	7,5	8,2	8,2	6,4	6,8	7,2	7,2
	kW	7	7,4	8	8	6,6	6,9	7,5	7,5	6,4	6,8	7,2	7,2	5,8	6	6,5	6,5	5,1	5,4	5,8	5,8
ECP28 2V54 C	kVA	11,5	12,4	13,2	13,2	10,7	11,6	12,4	12,4	10,5	11,3	12	12	9,5	10	10,9	10,9	8,4	9	9,6	9,6
	kW	9,2	9,9	10,6	10,6	8,6	9,3	9,9	9,9	8,4	9	9,6	9,6	7,6	8	8,7	8,7	6,7	7,2	7,7	7,7
ECP28 1S4 C	kVA	14,3	15,3	16,5	16,5	13,3	14,3	15,5	15,5	13	13,9	15	15	12	12,5	13,9	13,9	10,4	11,1	12	12
	kW	11,4	12,2	13,2	13,2	10,7	11,4	12,4	12,4	10,4	11,1	12	12	9,6	10	11	11	8,3	8,9	9,6	9,6
ECP28 2S4 C	kVA	17	18,1	19,8	19,8	15,9	16,8	18,5	18,5	15,4	16,4	18	18	14,6	15,4	16,8	16,8	12,4	13,1	14,4	14,4
	kW	13,6	14,4	15,8	15,8	12,7	13,4	14,8	14,8	12,4	13,1	14,4	14,4	11,6	12,3	13,4	13,4	9,9	10,5	11,5	11,5
ECP28 3S4 C	kVA	19,8	21,1	23	23	18,5	19,7	21,6	21,6	18	19	21	21	17	18	19,6	19,6	14,4	15,3	16,8	16,8
	kW	15,8	16,8	18,5	18,5	14,8	15,7	17,3	17,3	14,4	15,3	16,8	16,8	13,6	14,4	15,6	15,6	11,5	12,2	13,4	13,4
ECP28 M4 C	kVA	23,1	25,3	26,4	26,4	21,5	23,6	24,6	24,6	21	23	24	24	19	20	22	22	16,8	18,4	19,2	19,2
	kW	18,5	20,2	21	21	17,2	18,9	19,7	19,7	16,8	18,4	19,2	19,2	15,2	16	17,6	17,6	13,4	14,7	15,4	15,4
ECP28 L4 C	kVA	28,6	30,3	33	33	26,5	28	30,6	30,6	26	27,5	30	30	24	25,5	27,5	27,5	20,8	22	24	24
	kW	22,9	24,2	26,4	26,4	21,2	22,4	24,5	24,5	20,8	22	24	24	19,2	20,4	22	22	16,6	17,6	19,2	19,2
ECP28 VL4 C	kVA	36,3	39,6	39,6	39,6	33,5	36,6	36,6	36,6	33	36	36	36	29	32	32	32	26,4	29	29	29
	kW	29	31,7	31,7	31,7	26,8	29,3	29,3	29,3	26,4	28,8	28,8	28,8	23,2	25,6	25,6	25,6	21,1	23	23	23

Reactance & Time constants- Class H / 400V

Unsaturated (ref. EN60034-4)		ECP28 1V54 C	ECP28 2V54 C	ECP28 1S4 C	ECP28 2S4 C	ECP28 3S4 C	ECP28 M4 C	ECP28 L4 C	ECP28 VL4 C	
X_d	Direct-axis synchronous reactance	%	233,2	228,8	207,7	196,9	217,3	200,6	215,5	185,8
X'_d	Direct-axis transient reactance	%	20,2	20	18,3	17,3	18,7	18,7	18,9	17,4
X''_d	Direct-axis subtransient reactance	%	14,4	14,3	11,8	11,2	12,7	10,6	10,7	9,9
X_q	Quadrature-axis synchronous reactance	%	85,5	83,4	71,1	67,6	79,9	87,1	88,6	80,1
X'_q	Quadrature-axis transient reactance	%	85,5	83,4	71,1	67,6	79,9	87,1	88,6	80,1
X''_q	Quadrature-axis subtransient reactance	%	30	28,2	24,8	23,5	26,4	24,4	24,4	21,5
X₂	Negative-sequence reactance	%	21,6	20,7	17,7	16,8	19	16,9	17	15,1
X₀	Zero sequence reactance	%	4,41	4,11	3,49	3,32	3,97	3,67	3,63	3,17
Saturated										
X_d	Direct-axis synchronous reactance	%	198,2	194,5	176,5	167,4	184,7	170,5	183,2	157,9
X'_d	Direct-axis transient reactance	%	17,2	17	15,6	14,7	15,9	15,9	16,1	14,8
X''_d	Direct-axis subtransient reactance	%	12,2	12,2	10	9,52	10,8	9,01	9,09	8,42
X_q	Quadrature-axis synchronous reactance	%	72,7	70,9	60,4	57,5	67,9	74	75,3	68,1
X'_q	Quadrature-axis transient reactance	%	72,7	70,9	60,4	57,5	67,9	74	75,3	68,1
X''_q	Quadrature-axis subtransient reactance	%	25,5	24	21,1	20	22,4	20,7	20,7	18,3
X₂	Negative-sequence reactance	%	18,4	17,6	15	14,3	16,2	14,4	14,4	12,8
X₀	Zero sequence reactance	%	4,41	4,11	3,49	3,32	3,97	3,67	3,63	3,17
K_{cc}	Short circuit ratio		0,5	0,51	0,57	0,6	0,54	0,59	0,55	0,63
T'_d	Transient time constant	sec	0,062	0,057	0,066	0,063	0,055	0,048	0,054	0,051
T''_d	Subtransient time constant	sec	0,023	0,025	0,028	0,026	0,02	0,015	0,015	0,013
T'_{do}	Open circuit time constant	sec	0,72	0,66	0,75	0,71	0,64	0,51	0,61	0,54
T_a	Armature time constant	sec	0,09	0,009	0,009	0,009	0,009	0,01	0,01	0,01

Additional information - Class H / 400V

I_o	Excitation current at no load	A	0,7	0,8	0,8	0,7	0,6	0,6	0,7	0,7
I_c	Excitation current at full load	A	3,0	2,9	3,2	2,6	2,0	1,8	1,9	2,4
Overload 1 hour in a 6 hours period 110% rated load										
Overload per 20 sec.		%	300							
Heat dissipation		W	1009	1302	1587	1857	2148	2391	2831	3242
Telephone Harmonic Factor - THF		%	<2	<2	<2	<2	<2	<2	<2	<2
Waveform Distors.(THD) full load LL/LN		%	1,5 / 1,5	1,7 / 1,6	1,8 / 1,7	1,5 / 1,5	1,7 / 1,6	1,5 / 1,6	1,5 / 1,4	2,1 / 2
Waveform Distors.(THD) no load LL/LN		%	3,5 / 3,5	3,4 / 3,3	3,5 / 3,5	3,4 / 3,4	3,5 / 3,4	3,2 / 3,2	3 / 2,9	3 / 3

Reactance & Time constants- Class H / 480V

Unsaturated (ref. EN60034-4)			ECP28 1V54 C	ECP28 2V54 C	ECP28 1S4 C	ECP28 2S4 C	ECP28 3S4 C	ECP28 M4 C	ECP28 L4 C	ECP28 VL4 C
X_d	Direct-axis synchronous reactance	%	233,2	228,8	207,7	196,9	217,3	200,6	215,5	185,8
X'_d	Direct-axis transient reactance	%	20,2	20	18,3	17,3	18,7	18,7	18,9	17,4
X''_d	Direct-axis subtransient reactance	%	14,4	14,3	11,8	11,2	12,7	10,6	10,7	9,9
X_q	Quadrature-axis synchronous reactance	%	85,5	83,4	71,1	67,6	79,9	87,1	88,6	80,1
X'_q	Quadrature-axis transient reactance	%	85,5	83,4	71,1	67,6	79,9	87,1	88,6	80,1
X''_q	Quadrature-axis subtransient reactance	%	30	28,2	24,8	23,5	26,4	24,4	24,4	21,5
X₂	Negative-sequence reactance	%	21,6	20,7	17,7	16,8	19	16,9	17	15,1
X₀	Zero sequence reactance	%	4,41	4,11	3,49	3,32	3,97	3,67	3,63	3,17
Saturated										
X_d	Direct-axis synchronous reactance	%	198,2	194,5	176,5	167,4	184,7	170,5	183,2	157,9
X'_d	Direct-axis transient reactance	%	17,2	17	15,6	14,7	15,9	15,9	16,1	14,8
X''_d	Direct-axis subtransient reactance	%	12,2	12,2	10	9,52	10,8	9,01	9,09	8,42
X_q	Quadrature-axis synchronous reactance	%	72,7	70,9	60,4	57,5	67,9	74	75,3	68,1
X'_q	Quadrature-axis transient reactance	%	72,7	70,9	60,4	57,5	67,9	74	75,3	68,1
X''_q	Quadrature-axis subtransient reactance	%	25,5	24	21,1	20	22,4	20,7	20,7	18,3
X₂	Negative-sequence reactance	%	18,4	17,6	15	14,3	16,2	14,4	14,4	12,8
X₀	Zero sequence reactance	%	4,41	4,11	3,49	3,32	3,97	3,67	3,63	3,17
K_{cc}	Short circuit ratio		0,5	0,51	0,57	0,6	0,54	0,59	0,55	0,63
T'_d	Transient time constant	sec	0,062	0,057	0,066	0,063	0,055	0,048	0,054	0,051
T''_d	Subtransient time constant	sec	0,023	0,025	0,028	0,026	0,02	0,015	0,015	0,013
T'_{do}	Open circuit time constant	sec	0,72	0,66	0,75	0,71	0,64	0,51	0,61	0,54
T_a	Armature time constant	sec	0,09	0,009	0,009	0,009	0,009	0,01	0,01	0,01

Additional information - Class H / 480V

I_o	Excitation current at no load	A	0,7	0,8	0,8	0,7	0,6	0,6	0,7	0,7
I_c	Excitation current at full load	A	3,0	2,9	3,2	2,6	2,0	1,8	1,9	2,4
Overload			1 hour in a 6 hours period 110% rated load							
Overload per 20 sec.		%	300							
Heat dissipation		W	1124	1460	1761	2001	2291	2397	2936	3271
Telephone Interference Factor - TIF			<45	<45	<45	<45	<45	<45	<45	<45
Waveform Distors.(THD) full load LL/LN		%	1,5 / 1,5	1,7 / 1,6	1,8 / 1,7	1,5 / 1,5	1,7 / 1,6	1,5 / 1,6	1,5 / 1,4	2,1 / 2
Waveform Distors.(THD) no load LL/LN		%	3,5 / 3,5	3,4 / 3,3	3,5 / 3,5	3,4 / 3,4	3,5 / 3,4	3,2 / 3,2	3 / 2,9	3 / 3

ECP28 4 C

Efficiencies @ 50Hz

Models		380V 50Hz					400V 50Hz					415V 50Hz					440V 50Hz				
		0.25	0.5	0.75	1	1.1	0.25	0.5	0.75	1	1.1	0.25	0.5	0.75	1	1.1	0.25	0.5	0.75	1	1.1
ECP28 1V54 C	%	85,6	87,2	86,9	85,9	85,4	85,8	87,1	86,8	85,6	85,1	86,0	87,1	86,9	85,9	85,4	-	-	-	-	-
ECP28 2V54 C	%	85,7	87,4	87,3	86,3	85,8	85,9	87,3	87,2	86,0	85,5	86,1	87,3	87,3	86,3	85,8	-	-	-	-	-
ECP28 1S4 C	%	86,4	87,9	87,6	86,6	86,1	86,6	87,8	87,5	86,3	85,8	86,8	87,8	87,6	86,6	86,1	-	-	-	-	-
ECP28 2S4 C	%	86,8	88,5	88,3	87,2	86,7	87,4	88,3	87,8	86,6	86,1	87,5	88,2	87,9	86,8	86,3	-	-	-	-	-
ECP28 3S4 C	%	87,8	88,7	88,1	87,0	86,5	88,0	88,6	88,0	86,7	86,2	88,2	88,6	88,1	87,0	86,5	88,7	88,9	88,4	87,2	86,8
ECP28 M4 C	%	88,1	89,0	88,3	87,3	86,8	88,3	89,1	88,2	87,0	86,5	88,5	89,1	88,5	87,3	86,8	89,0	89,2	88,6	87,5	87,1
ECP28 L4 C	%	88,9	89,9	89,0	87,6	87,1	89,0	89,8	88,9	87,6	87,1	89,0	89,8	88,8	87,3	86,9	-	-	-	-	-
ECP28 VL4 C	%	89,3	90,3	89,4	87,9	87,4	89,4	90,2	89,3	87,9	87,4	89,4	90,2	89,4	88,2	87,8	-	-	-	-	-

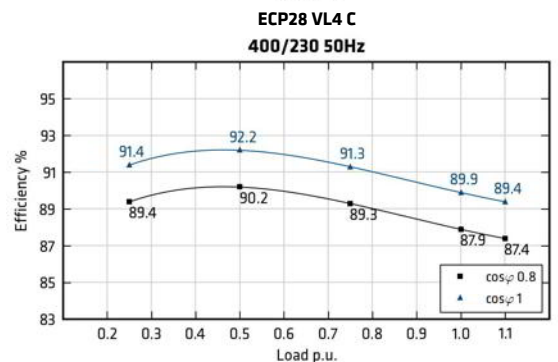
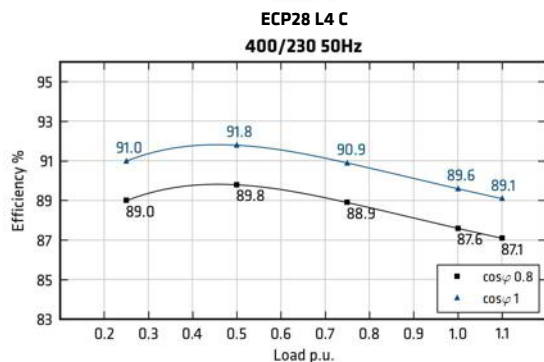
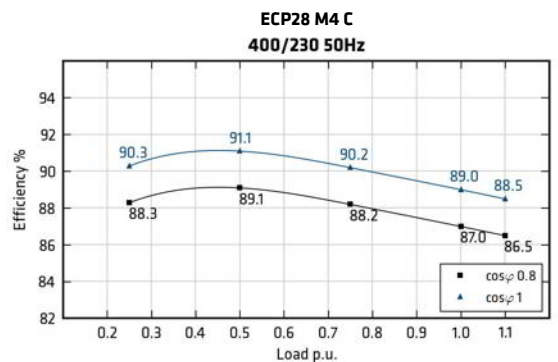
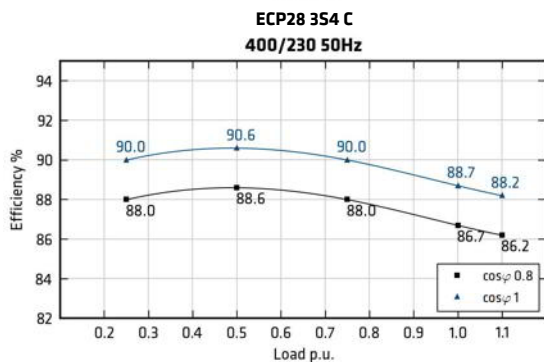
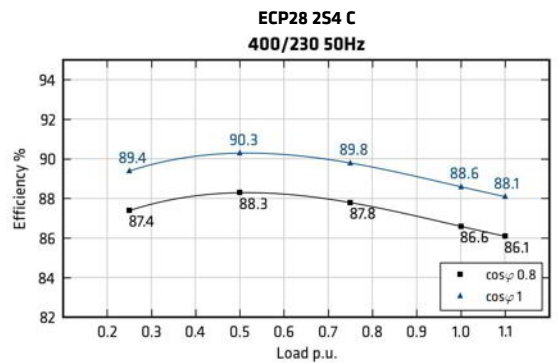
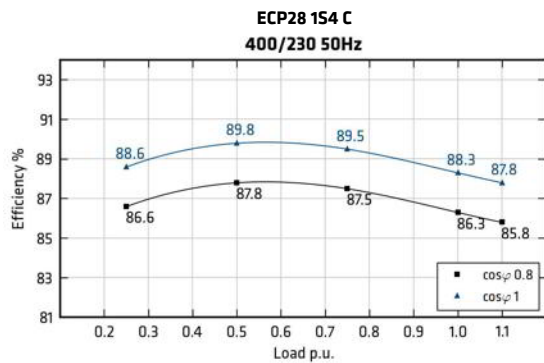
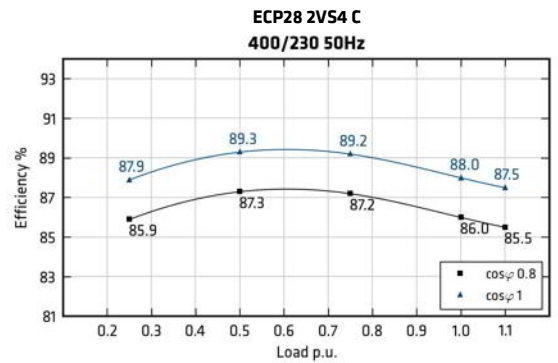
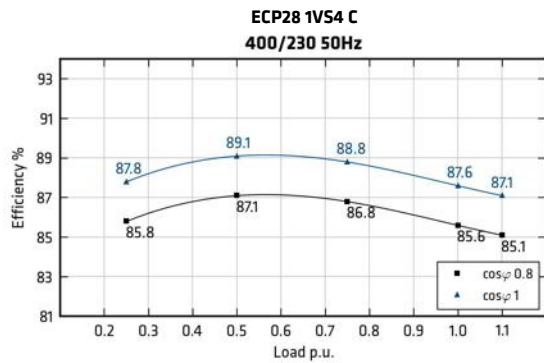

ECP28 4 C

Efficiencies @ 60Hz

Models		415V 60Hz					440V 60Hz					460V 60Hz					480V 60Hz				
		0.25	0.5	0.75	1	1.1	0.25	0.5	0.75	1	1.1	0.25	0.5	0.75	1	1.1	0.25	0.5	0.75	1	1.1
ECP28 1V54 C	%	85,2	87,0	87,2	86,6	86,1	85,4	87,0	86,9	86,3	85,9	84,9	86,8	87,1	86,6	86,2	85,2	86,9	87,0	86,5	86,1
ECP28 2V54 C	%	85,4	87,3	87,7	86,9	86,4	85,6	87,3	87,4	86,6	86,2	85,1	87,1	87,6	86,9	86,5	85,4	87,2	87,5	86,8	86,4
ECP28 1S4 C	%	86,1	88,0	88,2	87,3	86,8	86,3	88,0	87,9	87,0	86,6	85,8	87,8	88,1	87,3	86,9	86,1	87,9	88,0	87,2	86,8
ECP28 2S4 C	%	86,9	88,7	89,2	88,5	88,0	87,4	88,7	88,4	87,4	87,0	86,3	88,1	88,6	87,9	87,5	86,8	88,4	88,4	87,8	87,4
ECP28 3S4 C	%	87,2	88,6	88,7	88,1	87,6	87,3	88,6	88,4	87,8	87,4	86,8	88,4	88,6	88,1	87,7	87,1	88,5	88,5	88,0	87,6
ECP28 M4 C	%	89,1	89,8	89,7	89,0	88,5	89,4	89,9	89,4	88,7	88,3	88,8	89,6	89,6	89,0	88,6	88,7	89,7	89,5	88,9	88,5
ECP28 L4 C	%	89,9	90,5	90,1	89,0	88,4	90,0	90,6	89,8	88,5	88,0	89,6	90,3	90,0	88,9	88,3	89,5	90,4	89,9	89,1	88,6
ECP28 VL4 C	%	90,2	91,0	90,5	89,3	88,7	90,5	91,1	90,2	88,8	88,2	89,8	90,8	90,4	89,2	88,6	89,7	90,9	90,3	89,4	88,9

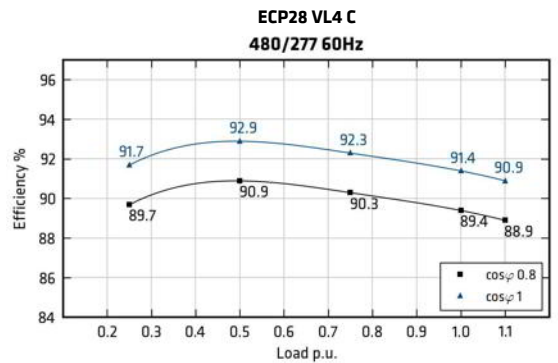
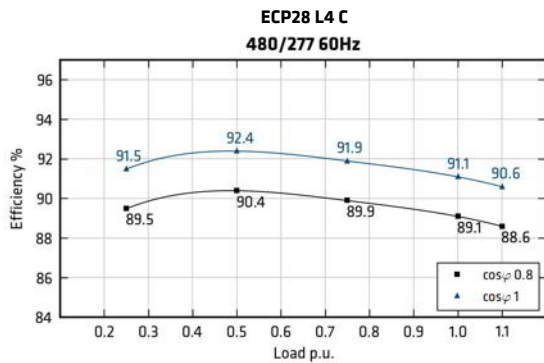
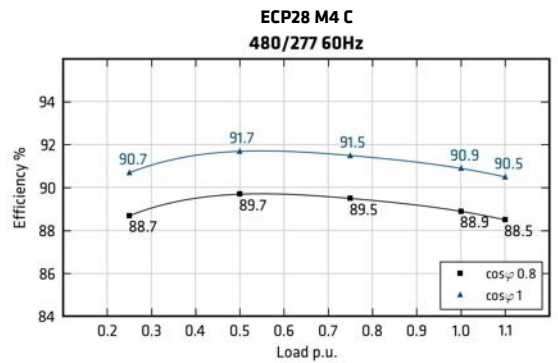
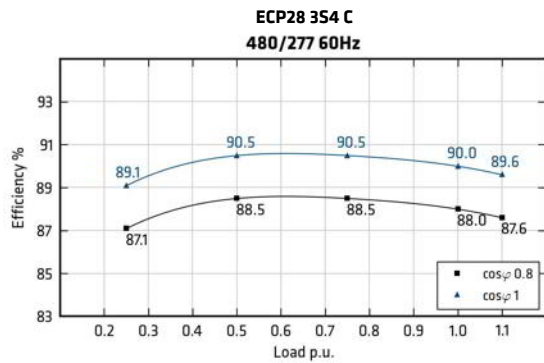
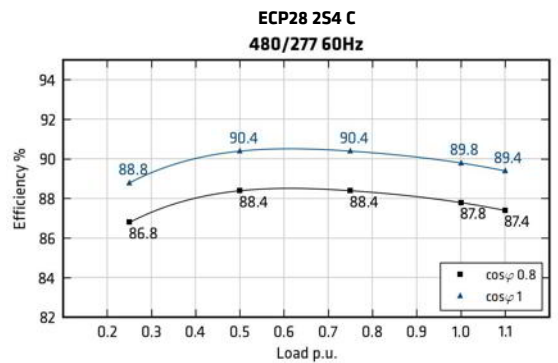
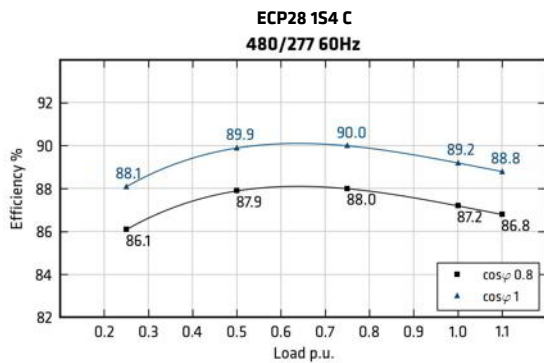
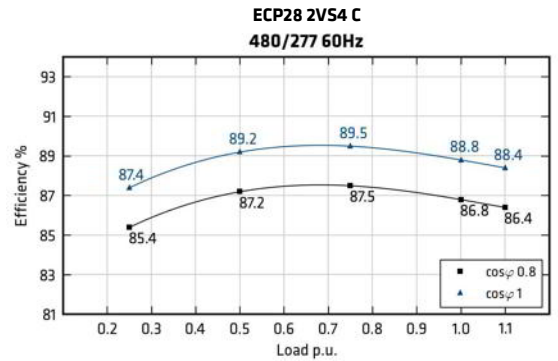
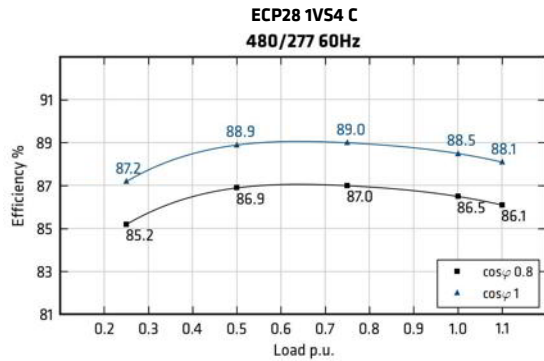

ECP28 4 C

Transients voltage

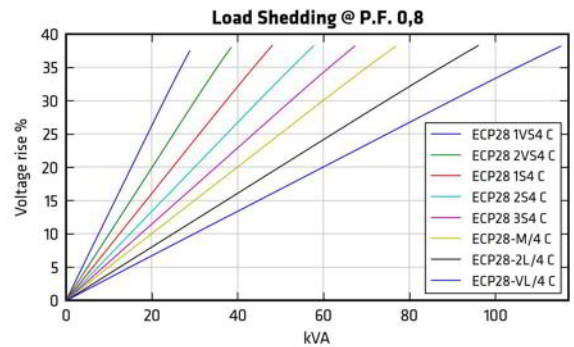
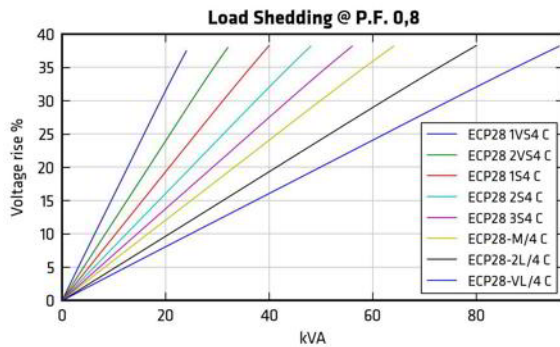
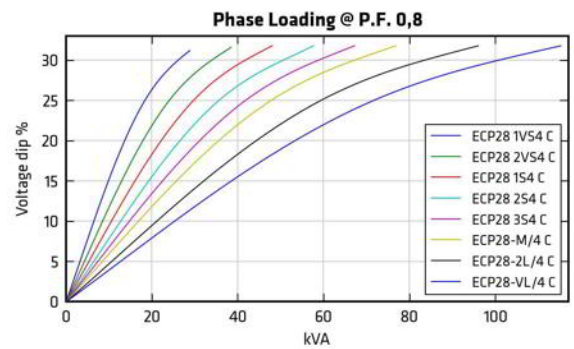
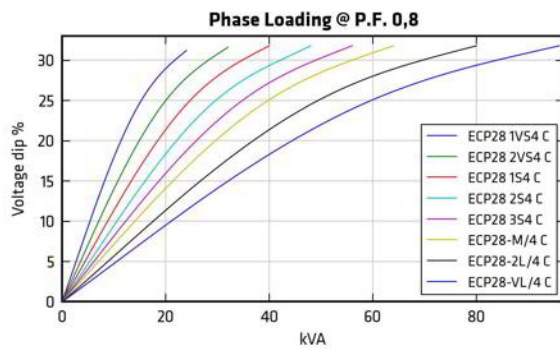
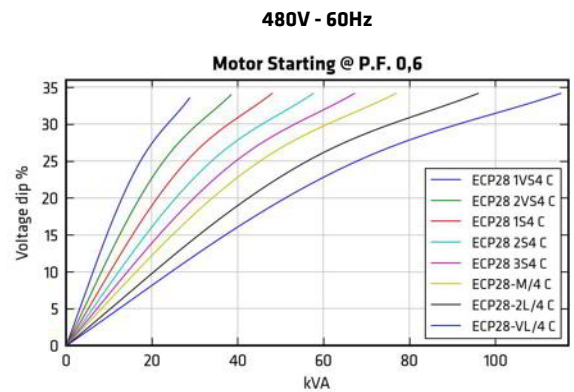
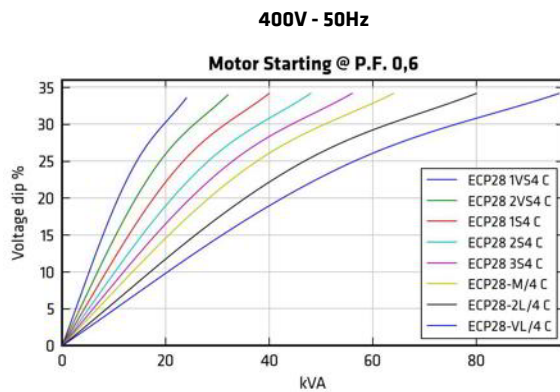

In order to scale transient curves as a function of a power factor or voltage if not indicated, please proceed as follows:

Power Factor coefficient corrector (PFCC), to be used on power factor 0.6 curves:

$$PFCC = \sin(\text{ARCCos}(PF_{\text{new}})) / 0.8$$

Example. The PFCC at power factor 0.3 is 1.192 [$PFCC = \sin(\text{ARCCos}(0.3)) / 0.8$]. This means that the voltage fall at a given power at pf 0.3 is equivalent to the one that can be read on the pf 0.6 curve if the load is considered 1.192 times bigger (19% higher value.).

In this example, a 100 kVA load insertion at pf 0.3 is equivalent in voltage fall to a 119kVA load insertion at pf 0.6.

Voltage coefficient corrector (VCC):

$$VCC = (400/V_{\text{new}})^2 \text{ if } 50 \text{ Hz}; VCC = (480/V_{\text{new}})^2 \text{ if } 60 \text{ Hz}$$

Example. VCC at 415V 60 Hz is 1.338 [$VCC = (480/415)^2$]. This means that the voltage fall at a given power at 415V is equivalent to the one that can be read on the power factor 0.6 curve if the load is considered 1.338 times bigger (33% higher value.).

In this example, a 100 kVA load insertion at 415V is equivalent in voltage fall to a 133kVA load insertion at 480V.

ECP28 4 C

50Hz Short circuit decrement curves - No load excitation at rated speed

ECP28 1VS4 C

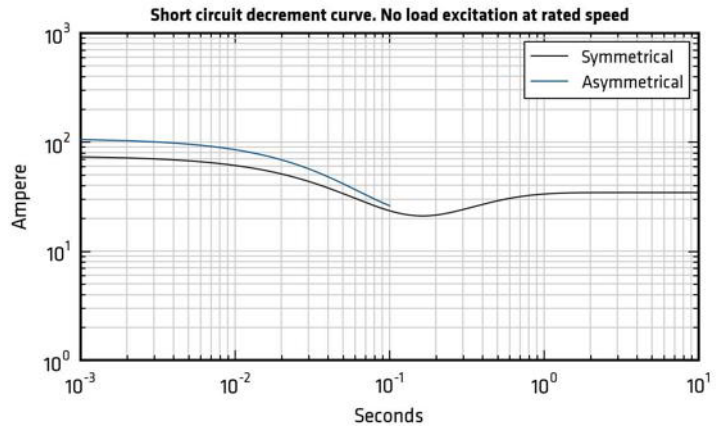

ECP28 2VS4 C

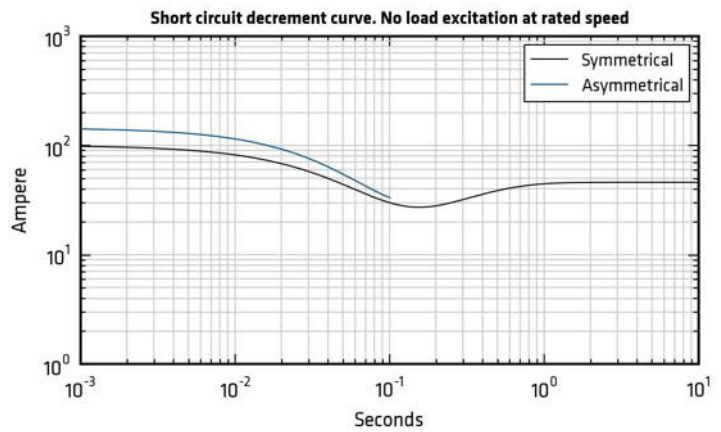

ECP28 1S4 C

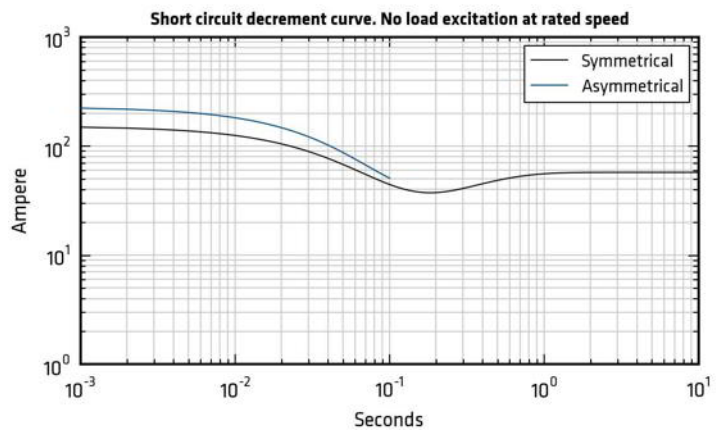

ECP28 2S4 C

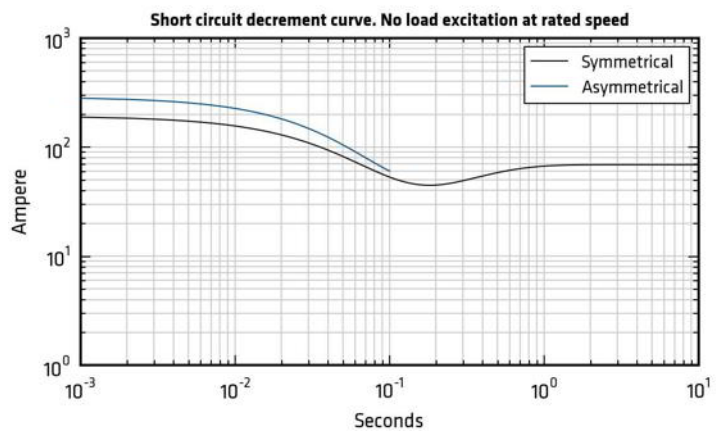

*Please refer to tables at page 6

ECP28 4 C

50Hz Short circuit decrement curves - No load excitation at rated speed

ECP28 3S4 C

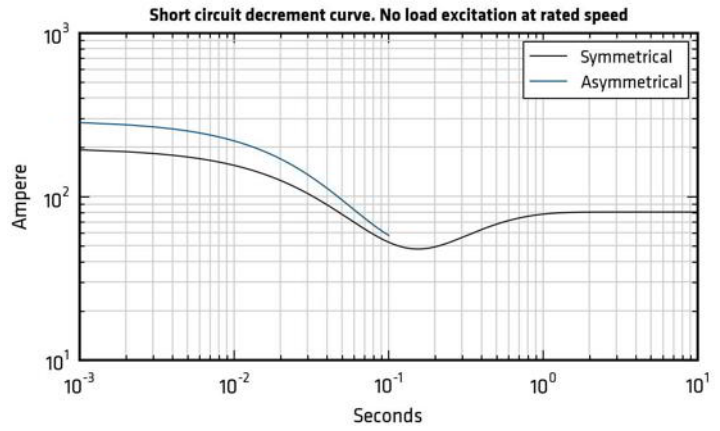

ECP28 M4 C

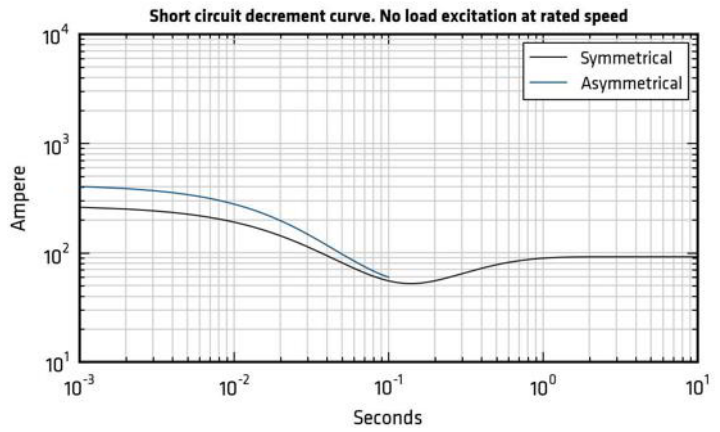

ECP28 L4 C

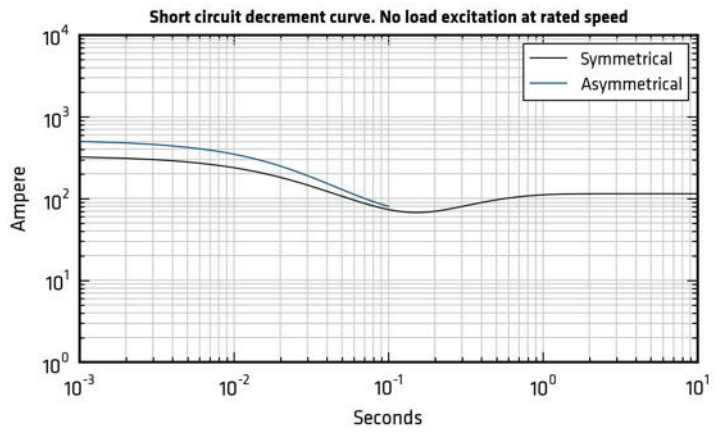

ECP28 VL4 C

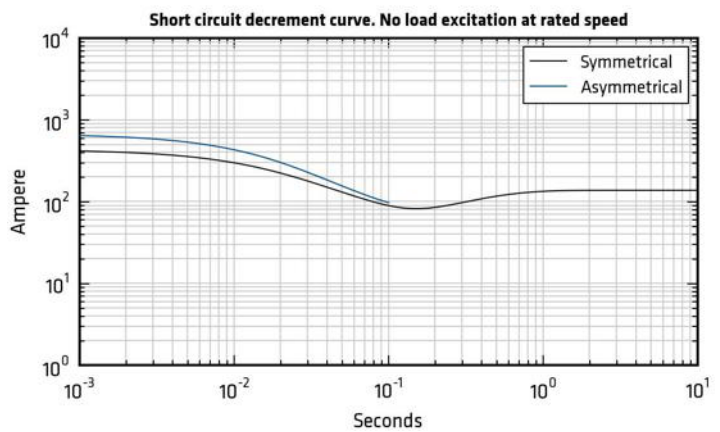

*Please refer to tables at page 6

ECP28 4 C

60Hz Short circuit decrement curves - No load excitation at rated speed

ECP28 1VS4 C

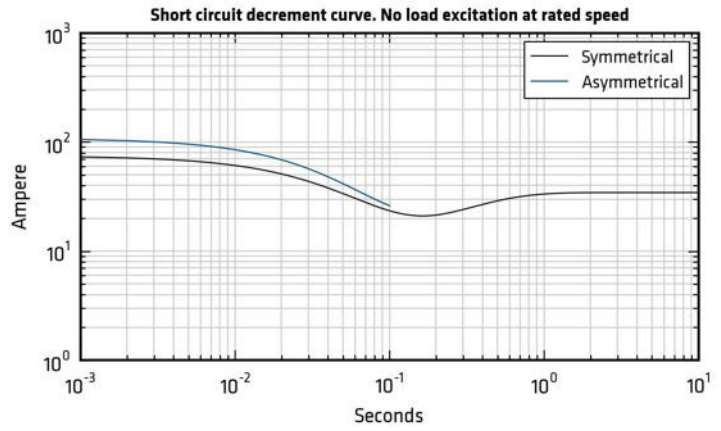

ECP28 2VS4 C

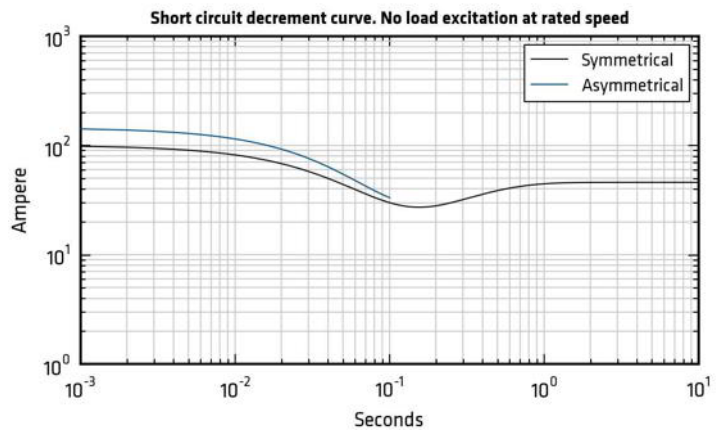

ECP28 1S4 C

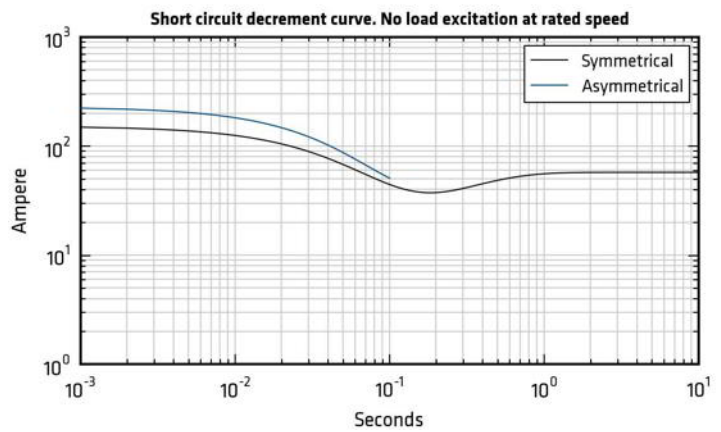

ECP28 2S4 C

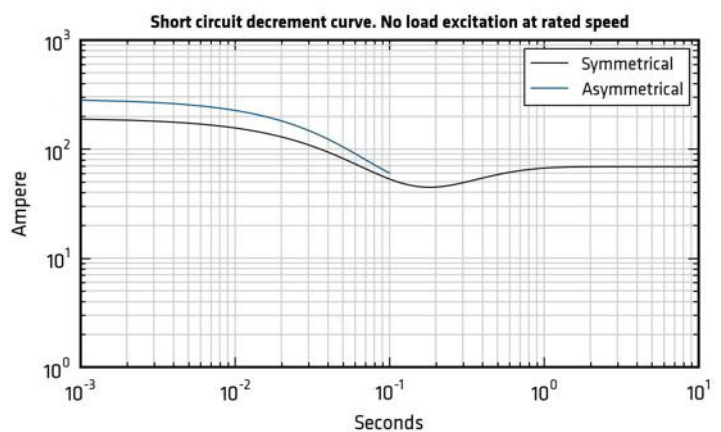

*Please refer to tables at page 6

ECP28 4 C

60Hz Short circuit decrement curves - No load excitation at rated speed

ECP28 3S4 C

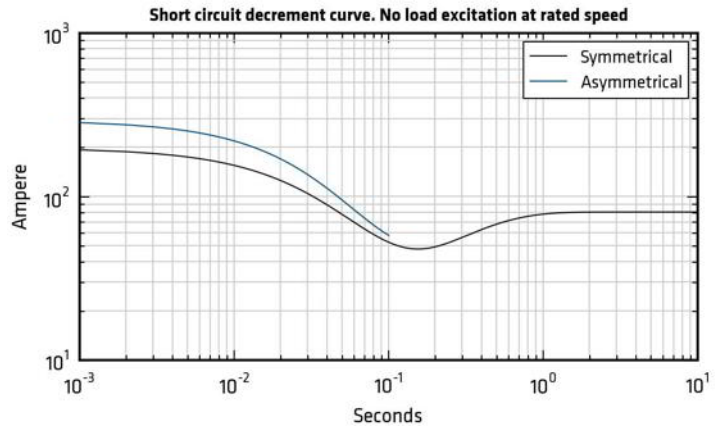

ECP28 M4 C

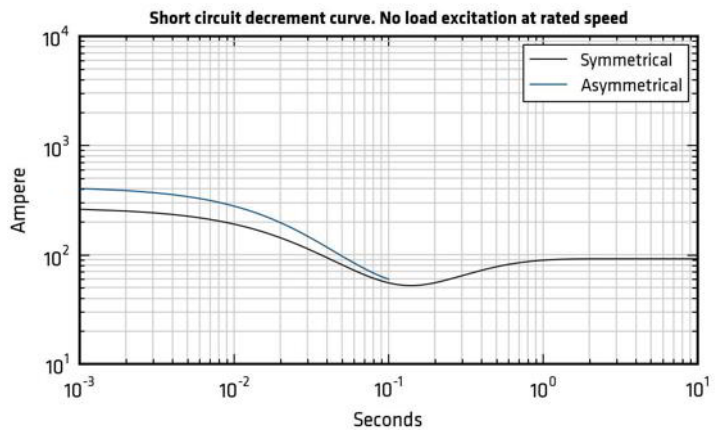

ECP28 L4 C

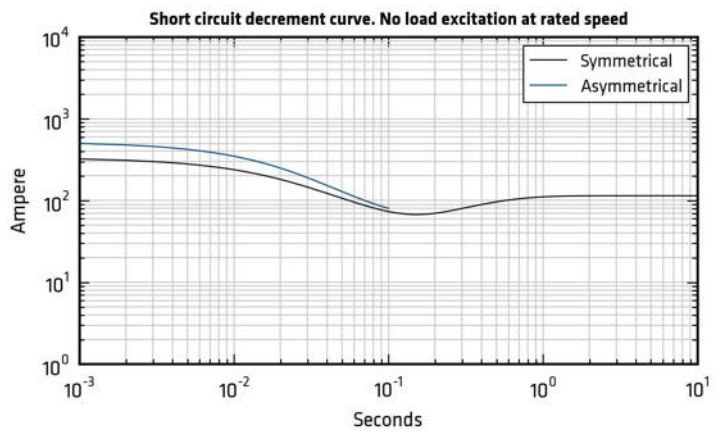

ECP28 VL4 C

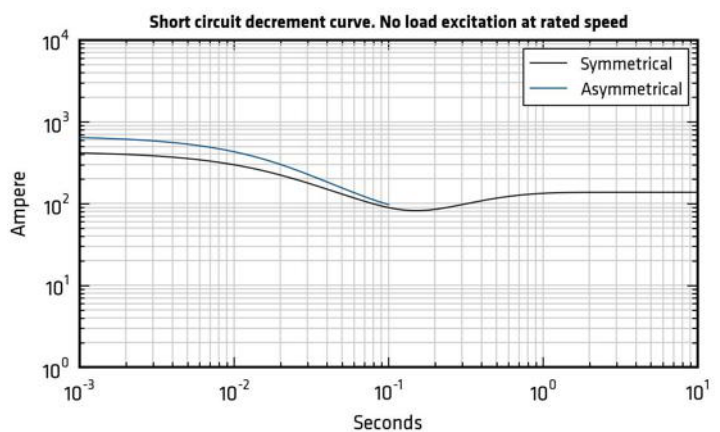

*Please refer to tables at page 6

ECP28 4 C

Additional Characteristics

Data	ECP28 1V54 C		ECP28 2V54 C		ECP28 1S4 C		ECP28 2S4 C		ECP28 3S4 C		ECP28 M4 C		ECP28 L4 C		ECP28 VL4 C	
	50Hz	60Hz	50Hz	60Hz	50Hz	60Hz	50Hz	60Hz	50Hz	60Hz	50Hz	60Hz	50Hz	60Hz	50Hz	60Hz
Damper cage	Aluminium															
Stator Winding Resistance (20°C)	Ω		0,854	0,578	0,423	0,318	0,297	0,227	0,168	0,128						
Rotor Winding Resistance (20°C)	Ω		0,904	0,986	1,067	1,123	1,204	1,314	1,505	1,75						
Stator Exciter Resistance (20°C)	Ω		9,6	9,6	9,6	9,6	9,6	9,6	9,6	9,6						
Rotor Exciter Resistance (20°C)	Ω		0,384	0,384	0,384	0,384	0,384	0,384	0,384	0,384						
Weight of complete generator	kg		73,0	79,1	87,4	91,5	96,9	106,0	121,9	141,8						
Unbalanced magnetic pull	kN/mm		2,9	3,0	2,8	2,9	3,0	3,6	4,3	4,6						
Air flow	m ³ /min		6,6	8,0	6,6	8,0	6,6	8,0	6,6	8,0	6,6	8,0	6,6	8,0	6,6	8,0
Noise level at 1m/7m	dB(A)		68/57	71/61	68/57	71/61	68/57	71/61	68/57	71/61	68/57	71/61	68/57	71/61	68/57	71/61

PQ Diagram

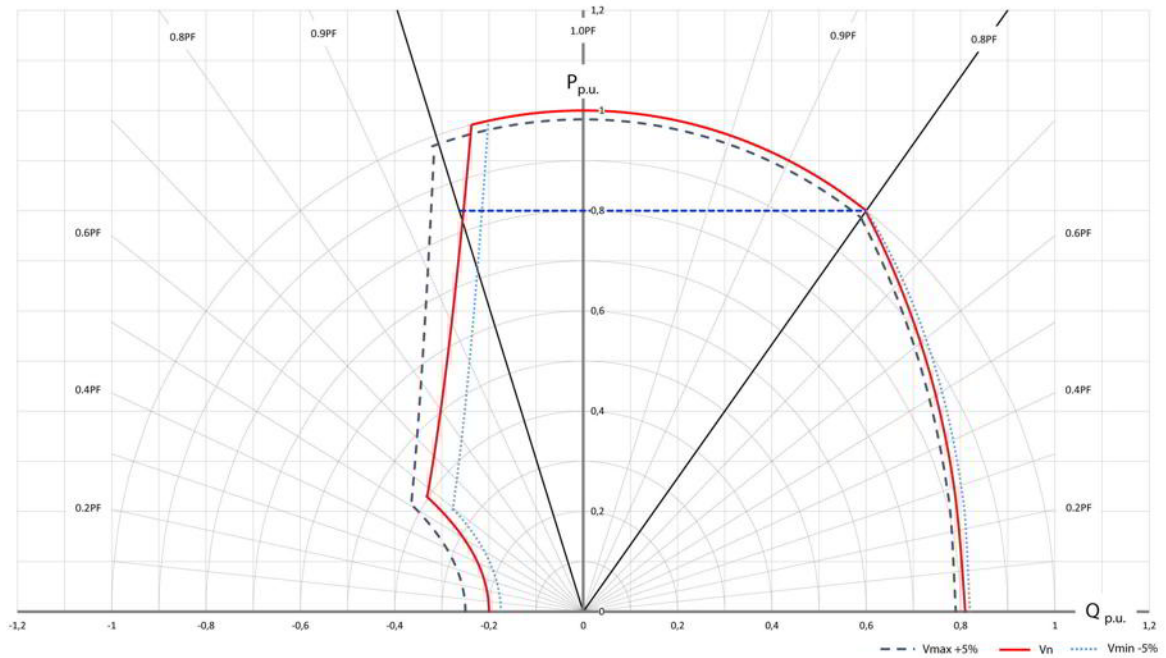

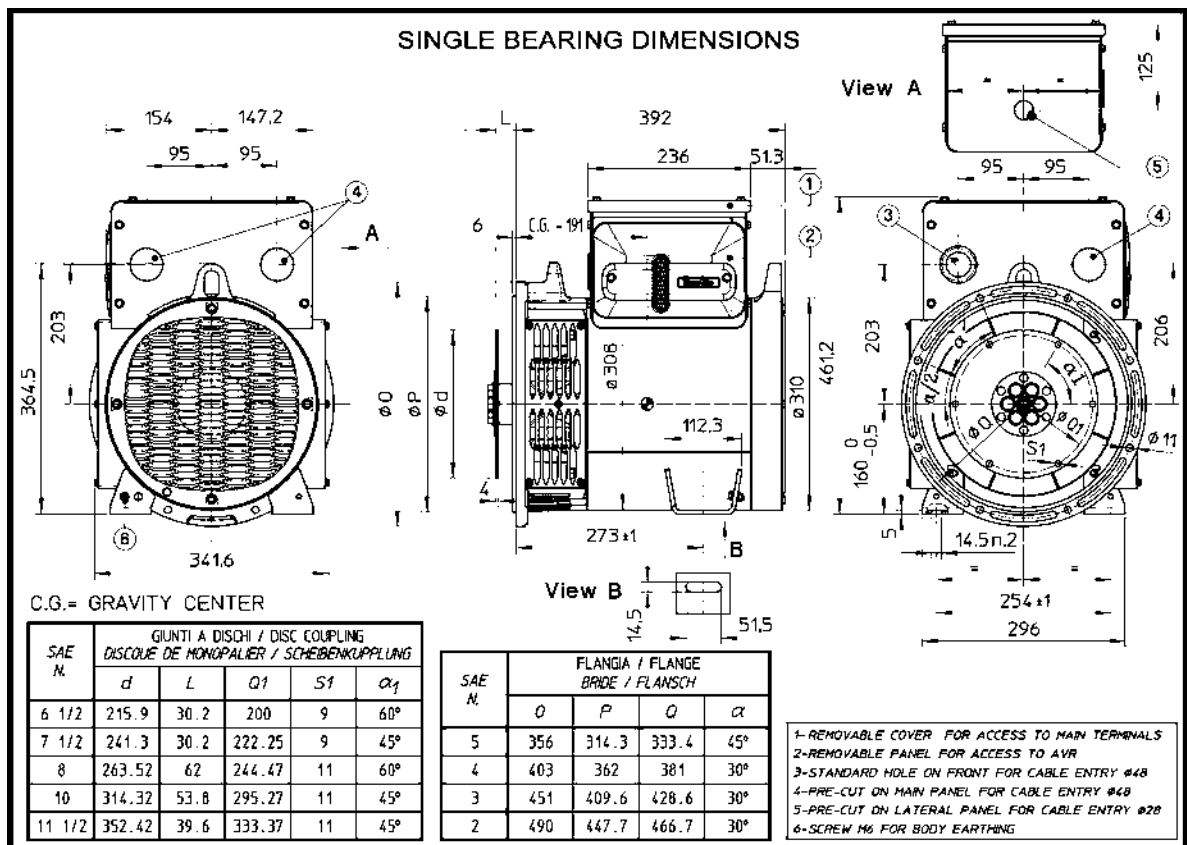
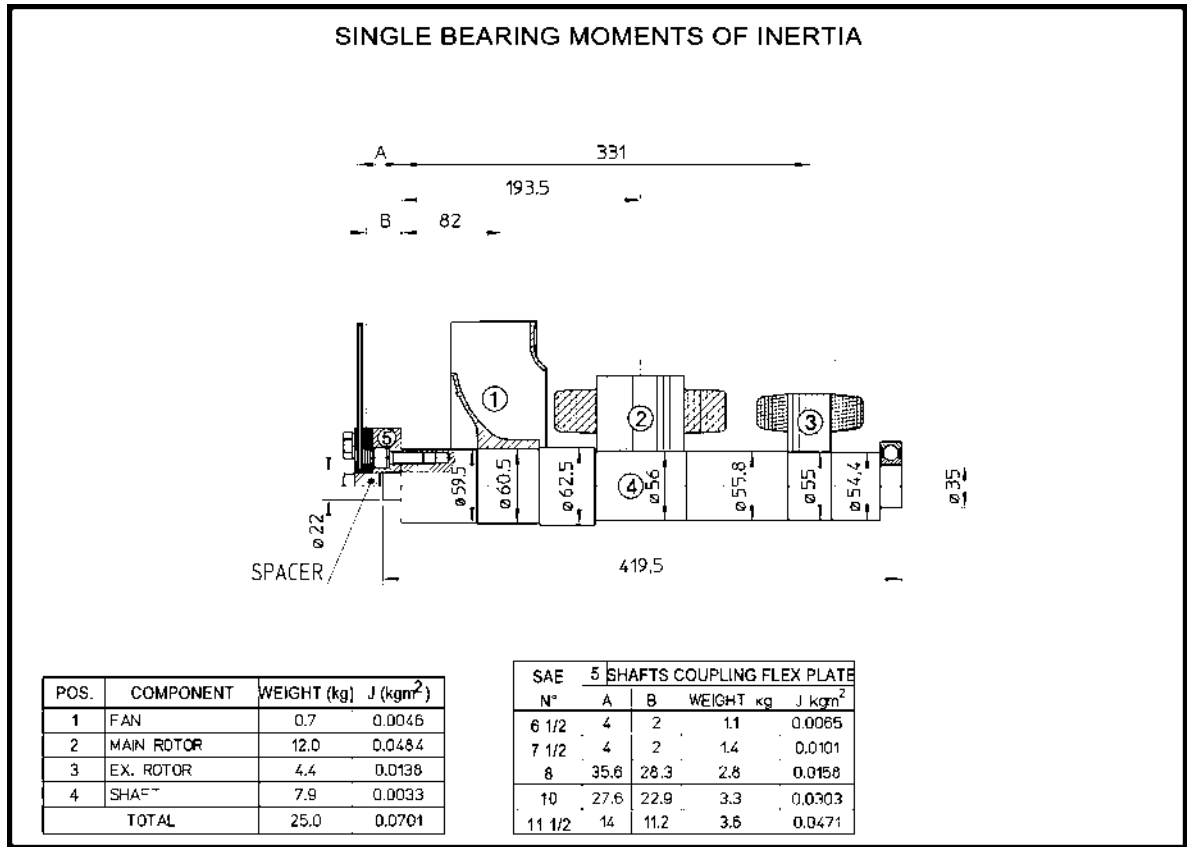

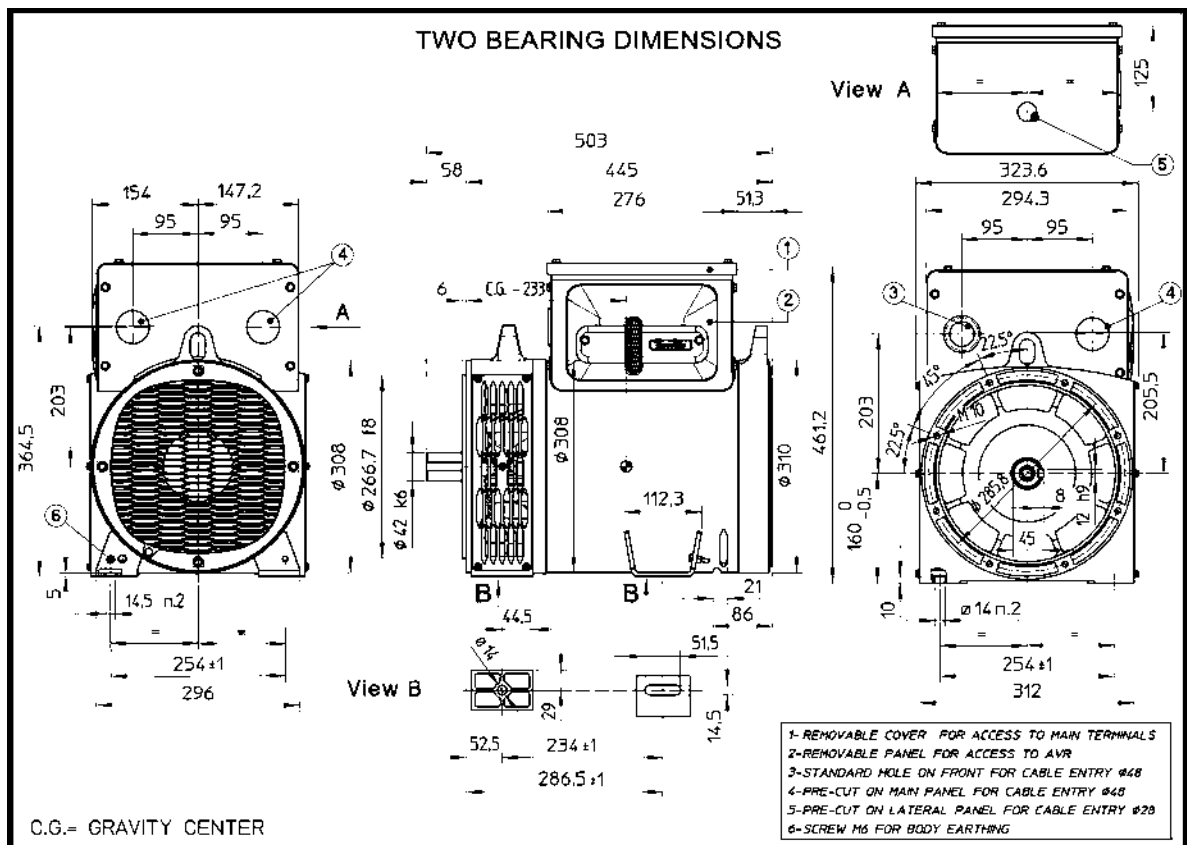
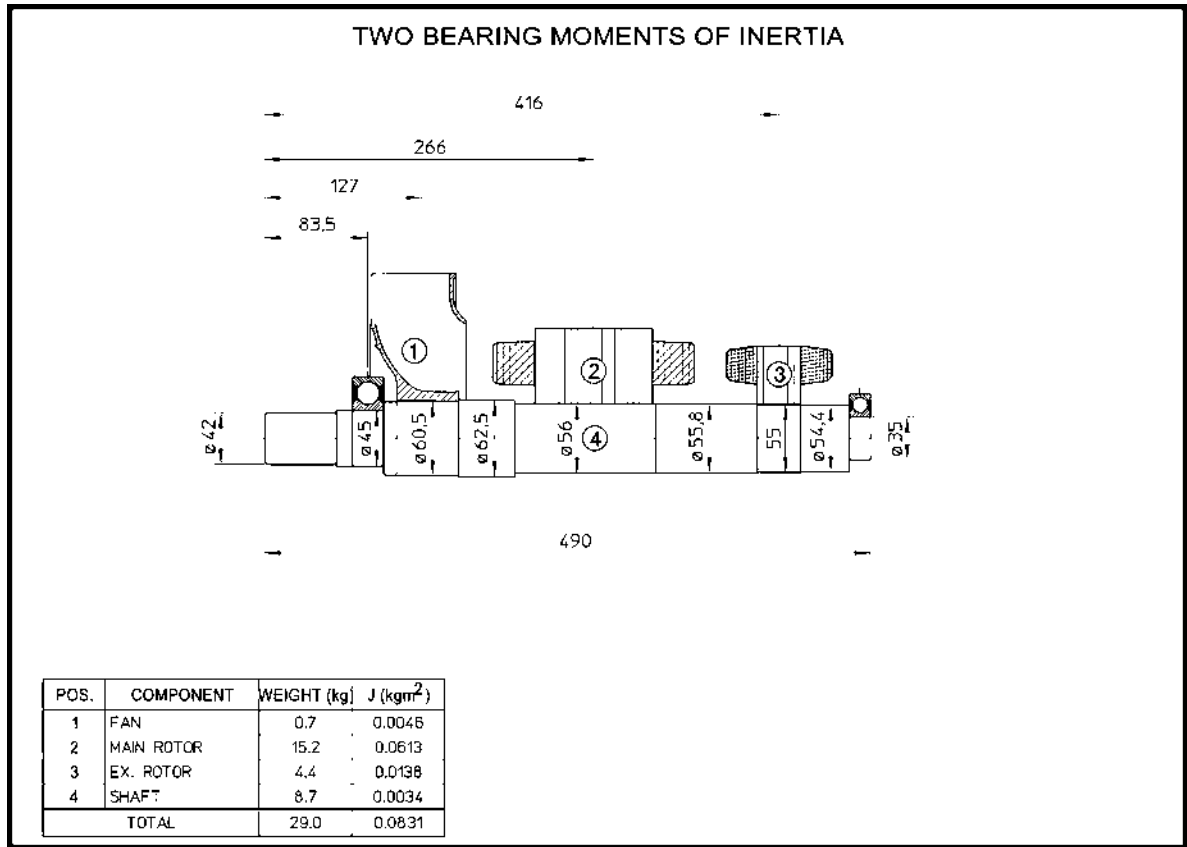

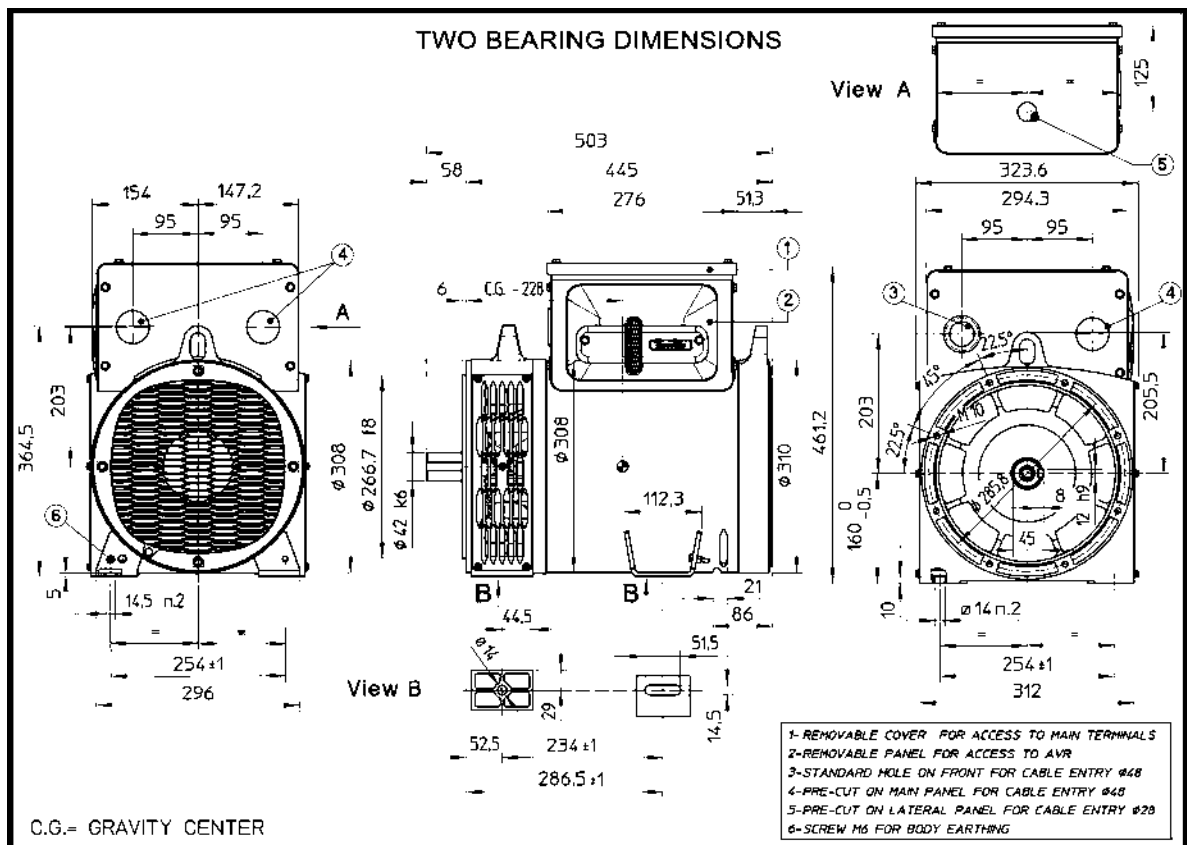
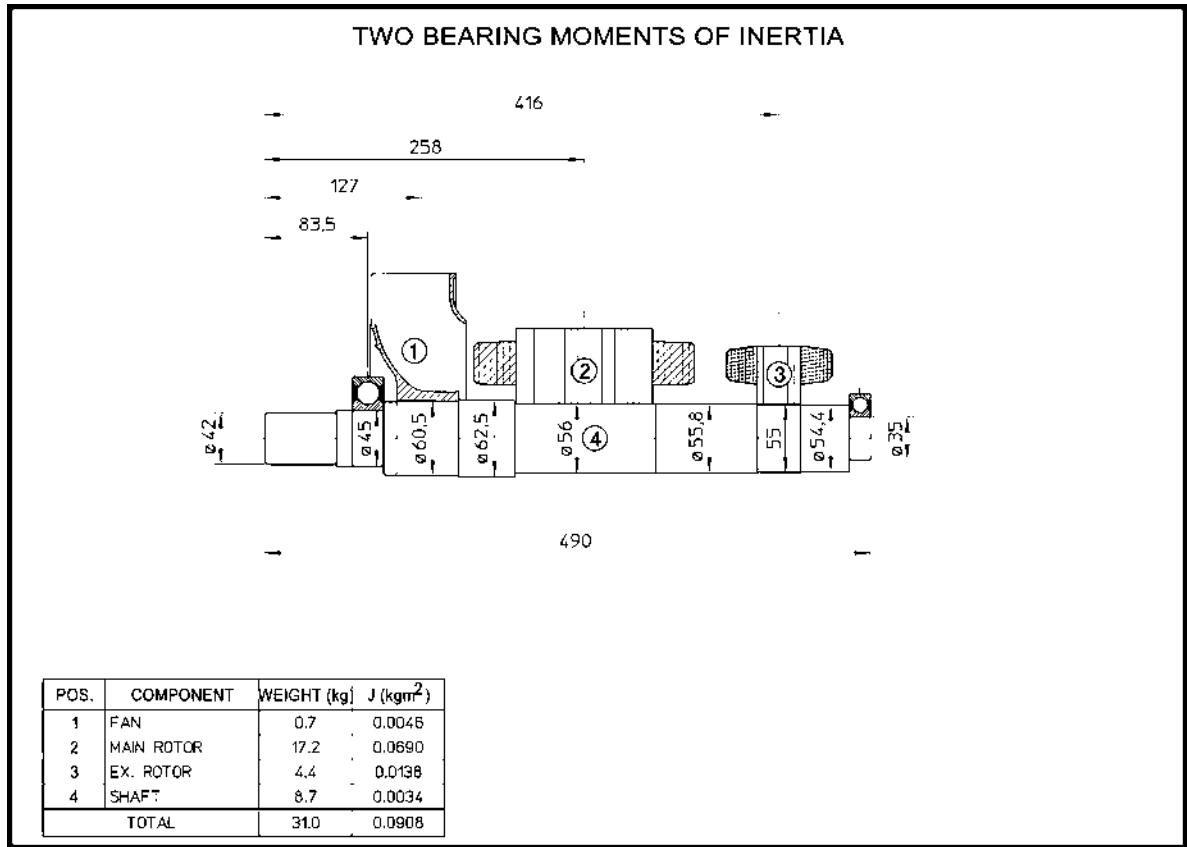

ECP28 4 C

ECP28 3S4 C

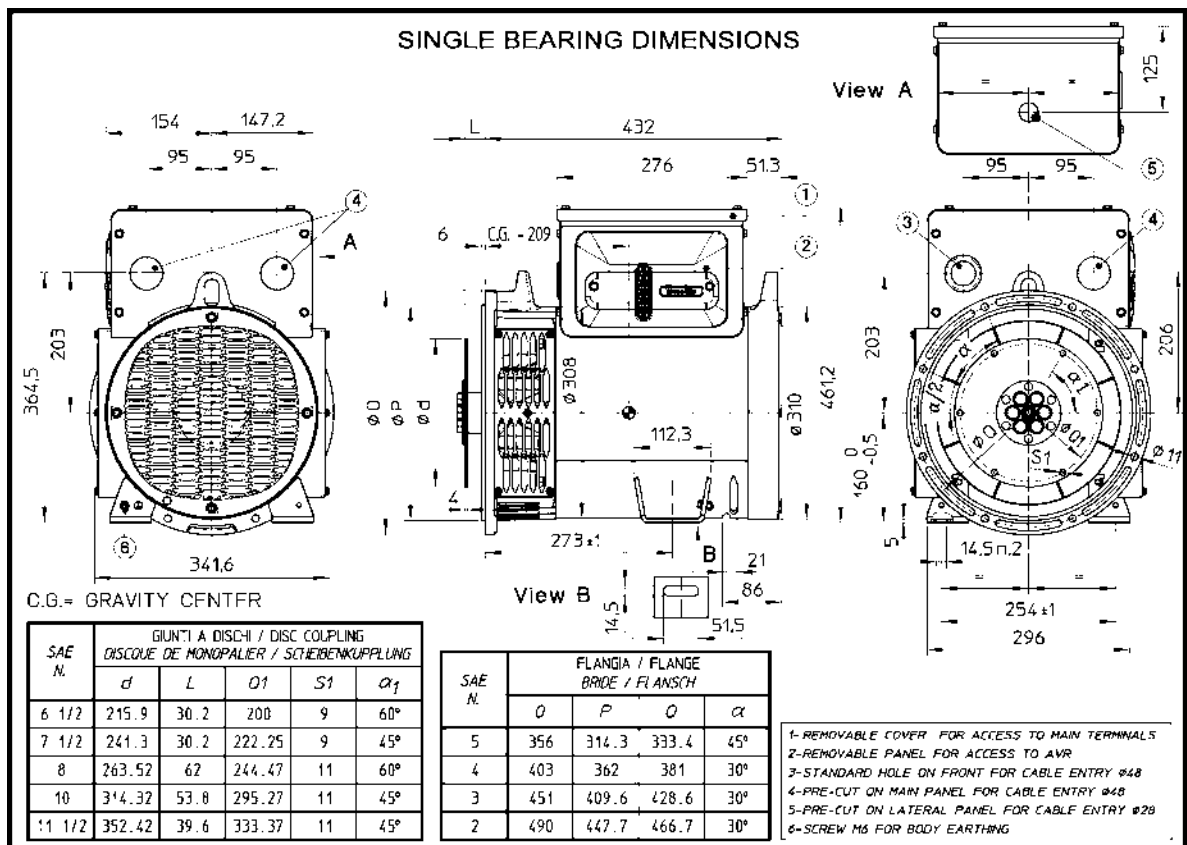
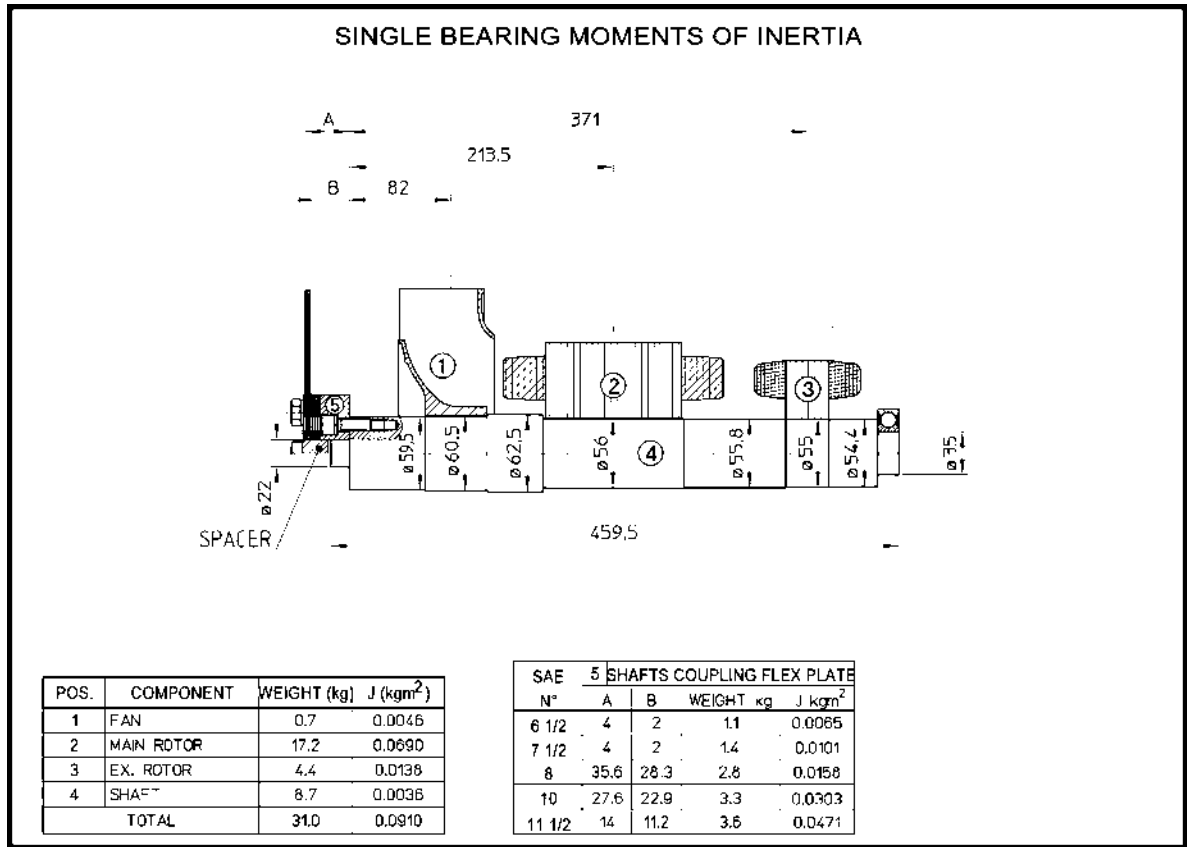

ECP28 4 C

ECP28 M4 C

